

User Manual

snom 300 | 320 | 360 | 370

deutsch

english

español

français

italiano



130907_UMEV21_AF

Table of Contents

Welcome	1
Copyright	1
Warranty.....	1
Declaration of conformity.....	1
Important User Information	2
Safety instructions.....	2
Disposal of the product.....	2
Overview	3
Hardware Components.....	3
snom 300	3
snom 320	3
snom 360	4
snom 370	4
(1) Display	5
(2) Keypad and LEDs.....	5
(3) Audio Devices.....	9
User Interfaces	10
User and Administrator Mode.....	10
Documentation	10
Getting Started	11
Phone Installation.....	11
Phone Initialization.....	12
(1) Hardware Self-Test.....	12
(2) TFTP Update Screen	12
(3A) Automatic Phone Initialization.....	12
(3M) Manual Phone Initialization.....	14
Registration	19
Successful Registration.....	19
Unsuccessful Registration	19
Idle Screen	20
Default Idle Screen.....	20
Customized Idle Screen	20
User Interfaces	22
Phone User Interface	22
Menu Structure	22
Settings Menu	25

Web User Interface	26
Access	26
Phone Configuration Changes	27
Phone Configuration	28
General Configuration Tasks	28
Language	28
Time and Date	29
Keyboard Lock	29
Display Format.....	30
Display Configuration Tasks	31
Display Contrast	31
Backlight Mode	32
Audio Configuration Tasks	33
Volume	33
Headset Use	34
Ringtones	35
SIP Identity Configuration Tasks.....	38
Adding / Editing Extensions.....	38
Blocking Extensions.....	39
Removing Extensions	39
Function Key Configuration Tasks.....	40
Input fields	40
Key Types	40
Maintenance Tasks.....	46
Administrator Password.....	46
Operation Modes.....	46
Firmware Update	47
Reboot	51
Factory Reset.....	52
Basic Call Functions	53
Outgoing Calls	53
Extension (SIP identity) for Outgoing Calls	53
Making Calls	54
Auto Completion (Number Guessing)	58
Call Completion	59
Call Termination	62
Redial	62
Incoming Calls	63

Call Indication.....	63
Accepting Incoming Calls	64
Call Waiting	64
Denying Incoming Calls.....	66
Denying Incoming Calls Automatically.....	66
DND (Do Not Disturb) Mode.....	67
Call Forwarding.....	68
Active Calls	71
Audio Operation Modes	71
Mute / Unmute.....	72
Multiple Speaker Mode	73
Hold and Resume.....	74
Call Transfer.....	76
Conference	77
Call Recording	78
Advanced Phone Functions	79
Hot Desking	79
Logoff All Users (Extensions/SIP Identities).....	79
Logon New User (Extension/SIP Identity).....	80
Directory.....	81
Call Lists	82
Minibrowser.....	83
Availability	83
Access	83
Presence.....	84
Changing the Presence State.....	85
Contact Presence	86
Voice Mailbox.....	87
Acoustical Indication.....	87
Visual Indication	88
Retrieve New Messages.....	88
Extension Monitoring and Call Pickup.....	89
Busy Lamp Field (BLF) feature	89
“Calls” List	90
Call Pickup	90
Appendix	91
Mapping of Context-Sensitive Function Keys	91
Idle screen	91
Basic navigation.....	91

“Edit” / “Enter number” screen	92
“Ringing”, “Calling”, “Connected”, “Holding”, “Transfer”, “Conference” screens	92
Mapping of Key Events.....	93
Idle Screen	94
Accessories.....	95
Expansion Module	95
Headsets	95
Wireless Headset Adapter.....	96
Power Consumption	97
FCC Statement	97
Endnotes.....	98

Welcome

Welcome to the user guide for the snom3x0 VoIP phones.

This manual describes the available features of the phone when it is connected to a SIP (RFC 3261) compliant PBX.

The functions and features available with this phone are designed for easy use in many different phone handling situations. The user manual describes the functions and features of the snom3x0 VoIP phones as they are programmed for delivery from the factory. There may be some differences in the way your phone is programmed. Please consult your system administrator if you need further information.

Note: The snom3x0 VoIP phones are IP phones that conform to the SIP standard (RFC 3261), and they can only be used within a network that supports this type of phone.

Copyright

All rights reserved. No parts of this publication may be reproduced, stored in retrieval systems, or transmitted in any form or by any means electronic, mechanical, photocopying, recording, or otherwise, without prior written permission of the publisher except in accordance with the following terms:

When this publication is made available on snom media, snom technology AG gives its consent to downloading and printing copies of the content provided in this file only for private use and not for redistribution. No parts of this publication may be subject to alteration, modification or commercial use. snom technology AG will not be liable for any damages arising from use of an illegally modified or altered publication.

Warranty

SNOM TECHNOLOGY AG MAKES NO WARRANTY OF ANY KIND WITH REGARD TO THIS MATERIAL, INCLUDING, BUT NOT LIMITED TO, THE IMPLIED WARRANTIES OF MERCHANTABILITY AND FITNESS FOR A PARTICULAR PURPOSE. snom technology AG shall not be liable for errors contained herein nor for incidental or consequential damages in connection with the furnishing, performance, or use of this material.

Declaration of conformity

 *Hereby, snom technology AG, declares that this phone is in conformity with the essential requirements and other relevant provisions of the European R&TTE directive 1999/5/EC.*

Details to be found at: <http://www.snom.com>.

Important User Information

Safety instructions

Save these instructions. Read these safety instructions before use!

ⓘ Note: *When using your phone or connected equipment, the following basic safety precautions should always be followed to reduce risk of fire, electrical shock, and other personal injury.*

- Follow instructions in the equipment's user manual or other documentation.
- Always install equipment in a location and environment for which it is designed.
- For locally powered ac electrical outlet use: Only operate within the specified transformer power voltage indicated. If you are uncertain of the type of power supplied within the building, consult property management or your local power company.
- For locally powered AC electrical outlet: Avoid placing the phone's power cable where it can be exposed to mechanical pressure as this may damage the cable. If the power supply cord or plug is damaged, disconnect the product and contact qualified service personnel.
- Headsets used with this equipment must comply with EN/IEC 60950-1 and for Australia AS/NZS 60950.1-2003.
- Do not make any changes or modifications to equipment without seeking approval from the party responsible for compliance. Unauthorized changes or modifications could void warranties and the user's authority to operate the equipment.
- Do not use the phone to report a gas leak in the vicinity of the leak!
- Do not spill liquid of any kind on the product or use the equipment near water, for example, near a bathtub, washbowl, kitchen sink, wet basement or near a swimming pool.
- Do not insert any object into equipment slots that is not part of the product or auxiliary product.
- Do not disassemble the product. Contact a qualified service agency when service or repair work is required.
- Do not use a phone (other than cordless type) during an electrical storm.

Disposal of the product

Your product should not be placed in municipal waste. Please check local regulations for disposal of electronic products.

Overview

Hardware Components

The main hardware components of your snom VoIP phone are the **display (1)**, the **keypad with LEDs (2)**, and the **audio devices (3)**.

snom 300

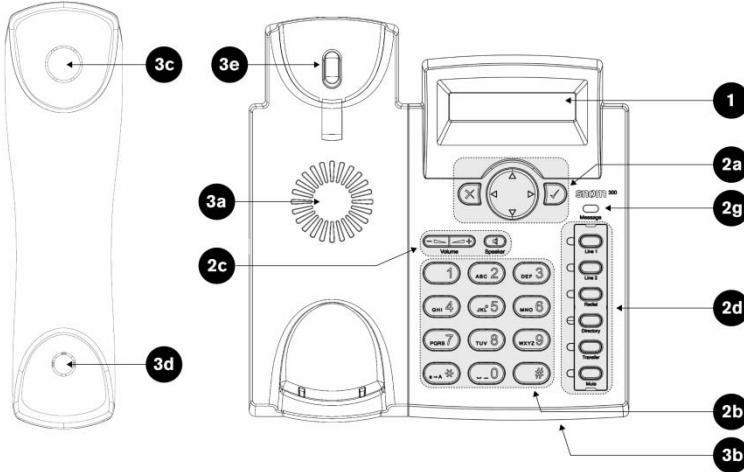

snom 320

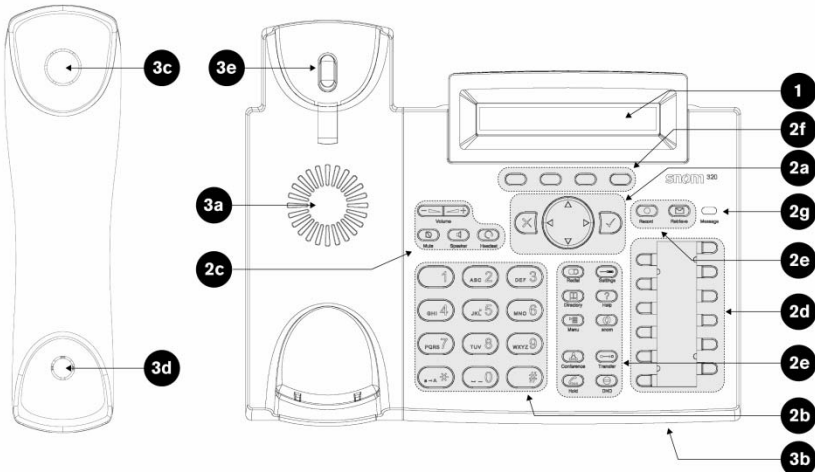

snom 360

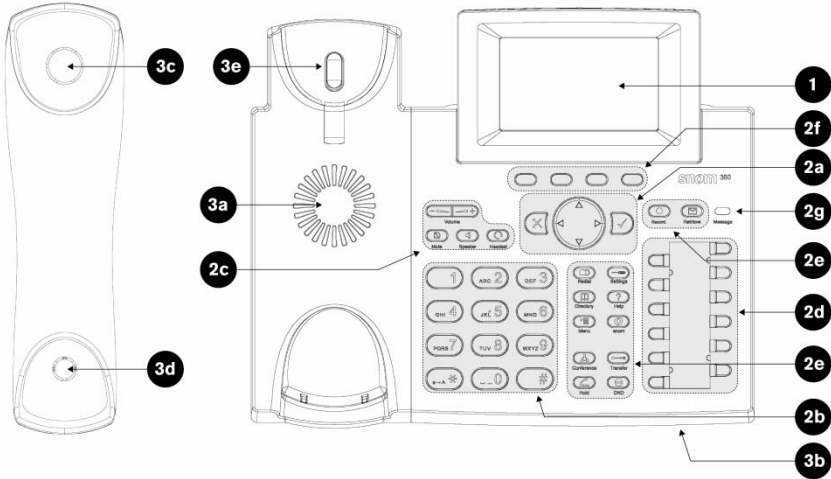

snom 370

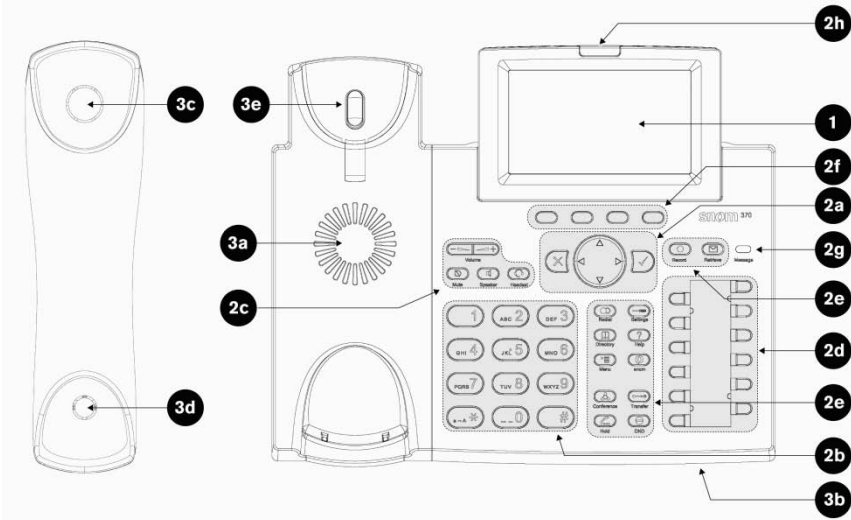

(1) Display

Features	snom 300	snom 320	snom 360	snom 370
Tilttable	x	✓ (0-45 degrees)		
Backlight	x	x	✓	✓
Type	Two-line LCD monochrome	Two-line LCD monochrome	Graphical LCD monochrome	Graphical LCD <i>grayscale</i>
Characters / pixels	16 characters per line	24 characters per line	128 x 64 pixels	240 x 128 pixels

(2) Keypad and LEDs







The keypad (including LEDs) is grouped in up to 8 functional units:

- a) Navigation Keys
- b) Alphanumeric Keys
- c) Audio Device Control Keys
- d) Free Function Keys with LEDs
- e) Preprogrammed Function Keys
- f) Context-Sensitive Function Keys
- g) Message LED
- h) Call Indication LED

Each unit is explained in the following subchapters in detail.











(2a) Navigation Keys

Use the navigation keys to navigate in the display menus and confirm and cancel actions.

snom 300 - snom 320 - snom 360 - snom 370					
Cancel	Up	Down	Left	Right	Confirm
					







(2b) Alphanumeric Keys

Use the alphanumeric keys to enter numbers, letters and special characters. Depending on the selected input mode (see page 54) you can enter digits, lower / upper case or special characters.

Input mode	snom 300 - snom 320 - snom 360 - snom 370		
			
Digits	1	2	3
Upper case	Special characters ¹	ABC2	DEF3
Lower case		abc2	def3
			
Digits	4	5	6
Upper case	GHI4	JKL5	MNO6
Lower case	ghi4	jkl5	mno6
			
Digits	7	8	9
Upper case	PQRS7\$	TUV8	WXYZ9
Lower case	pqrs7\$	tuv8	wxyz9
			
Digits	0		
Lower / Upper case	„space“, „_“, „0“		

























(2c) Audio Device Control Keys

Use the audio device control keys to perform the following actions depending on your phone type:

snom 300	snom 320 - snom 360 - snom 370
 Volume	 Adjusts the volume see page 33
 Speaker	 Toggles handsfree mode. see page 71
	 Redials a number. see page 62
	 Toggles headset mode. see page 71
	 Mutes / unmutes the microphone. see page 72

(2d) Free Function Keys













Free Function Keys are programmable keys which can be used for various functionalities (see page 39). If not otherwise stated the adjacent LED will light when the assigned functionality is turned on.

snom 300	snom 320 - snom 360 - snom 370
 LED1  L1 P1	 LED1 <div style="border: 1px solid black; padding: 2px; display: inline-block; text-align: center;">Label</div> LED7  P7
 LED2  L2 P2	 LED2 <div style="border: 1px solid black; padding: 2px; display: inline-block; text-align: center;">Label</div> LED8  P8
 LED3  Redial P3	 LED3 <div style="border: 1px solid black; padding: 2px; display: inline-block; text-align: center;">Label</div> LED9  P9
 LED4  Directory P4	 LED4 <div style="border: 1px solid black; padding: 2px; display: inline-block; text-align: center;">Label</div> LED10  P10
 LED5  Transfer P5	 LED5 <div style="border: 1px solid black; padding: 2px; display: inline-block; text-align: center;">Label</div> LED11  P11
 LED6  Mute P6	 LED6 <div style="border: 1px solid black; padding: 2px; display: inline-block; text-align: center;">Label</div> LED12  P12

(2e) Preprogrammed Function Keys

The preprogrammed function keys are preprogrammed as labeled. The following functions are mapped onto them:

snom 320 - snom 360 - snom 370

 Redial	Redials a number.	see page 62
 Directory	Calls up the phone directory.	see page 81
 Transfer	Transfers calls (if supported by your PBX).	see page 76
 Menu	Version 6: Calls up the main menu for configuration changes. Version 7: Not preprogrammed; reserved for future applications.	Version 6: see page 25
 Conference	Establishes a three-party conference call.	see page 77
 Hold	Places a call on "Hold" or resumes it.	see page 74
 Settings	Version 6: Calls up the "Maintenance" menu. Version 7: Calls up the "Settings" menu.	see page 25
 Record	Switches call recording on and off (if supported by your PBX).	see page 78
 Help	Calls up information about the phones: IP address, MAC Address, and Firmware Version	see page 26
 snom	Not preprogrammed.	
 DND	Switches "DND" mode on and off.	see page 67
 Retrieve	Retrieves messages from the voice mailbox (if supported by your PBX).	see page 87

(2f) Context-Sensitive Function Keys

The snom 320, snom 360, and snom 370 have context-sensitive function keys (S1 to S4) below the display. The current function of these keys is indicated by the text or symbol in the display above each key.

The key context for the idle screen can be customized (see page 18).

For the complete mapping see page 91 "Mapping of Context-Sensitive Function Keys".

(2g) Message LED

The “Message LED” is primarily used to visually indicate new voice messages stored on the mailbox of your PBX, (see page 87 “Voice Mailbox”).

When the following setting on your phone’s web user interface is set to “ON”, it can also be used to indicate the activities of your monitored extensions (Dialog State → see page 89 “Extension Monitoring and Call Pickup”) and to visually indicate missed calls.

☰ Setup → Preferences → General Information →
Message LED for Dialog State/Missed Calls: <ON>

Message Type	snom 300 - snom 320 – snom 360	snom 370
MWI	yellow (blinking)	red (blinking)
Incoming Call	yellow (blinking)	- (see 2h)
Missed Call	yellow (steady)	yellow (steady)
Dialog State	yellow (blinking)	yellow (blinking)
Info Message	-	-

(2h) Call Indication LED

The “Call Indication LED” is only available on the snom 370. It indicates incoming calls by a flashing red light.

(3) Audio Devices

Your phone is equipped with two different audio devices:

- Casing speaker (**3a**) and microphone (**3b**)
- Handset speaker (**3c**), microphone (**3d**), and hook switch (**3e**)

Optionally a headset can be attached as an additional audio device:

- Headset speaker and microphone

The audio Devices can be used in three operation modes:

1. **Handset mode** activates handset audio devices.
2. **Headset mode** activates headset audio devices.
3. **Handsfree mode** activates casing audio devices.

For information on switching audio operation modes, see page 71.

You can only use *one microphone* for talking, but you can choose up to *two speakers* for listening:



- Handset speaker / casing speaker or
- Headset speaker / casing speaker

For further details see page 73.

User Interfaces

The hardware components *keypad* and *display* constitute the *phone user interface* which allows the user to execute all call operation tasks and basic configuration changes *directly on the phone*. Additionally, each phone has a *web user interface* to make calls remotely and to access all configuration settings.

In many instances, it is possible to use both the *phone user interface* and the *web user interface* to operate the phone and change settings; some, however, are only possible via a phone or web user interface.

Interface	Symbol	Tasks	Links
Phone user interface		<ul style="list-style-type: none"> All call functions All basic settings 	See page 22
Web user interface		<ul style="list-style-type: none"> All basic and advanced settings No call functions except initiating & terminating calls 	See page 26

User and Administrator Mode

Your phone can be used in user or administrator mode. Administrator mode is the default setting with full configuration rights. For further details see page 46 / 47.

Note: The default administrator password is "0000" (four zeros).

Documentation

The following table shows all documentations available for snom phones.

Name	Contents	Where found	Format/ Language
Quick Start Guide	<ul style="list-style-type: none"> Contents of delivery and basic set up of phone 	<ul style="list-style-type: none"> In phone package 	-
User Manual	<ul style="list-style-type: none"> Phone user interface settings Web user interface settings Basic phone and call functions 	<ul style="list-style-type: none"> Download² 	<ul style="list-style-type: none"> PDF³ Multilingual

Note: For a complete set of user manuals refer to: <http://wiki.snom.com/Documentation>

Getting Started

Phone Installation

Install your phone using the “Quick Start Guide” included in the package:

Installation Step	snom 300	snom 320	snom 360	snom 370
Check contents of package	(A)	(A)	(A)	(A)
Attach the footstand for horizontal placement	(B)	factory fitted	factory fitted	factory fitted
Connect the following components to your phone We recommend this order:	(C)	(B)	(B)	(B)
		<ol style="list-style-type: none"> 1. Handset via handset cord 2. Optional: Expansion module⁴ 3. Network (+ optional: PoE) via Ethernet cable⁵ 4. Optional: Power supply (if PoE is not used) 5. Optional: PC via 2nd Ethernet cable⁵ 6. Optional: Headset⁵ 		
Adjust the display angle	Not applicable	(C)	(C)	(C)
Place the phone on an even, horizontal surface. Do not place it on carpets or other materials containing fibers that could block the air vents and cause overheating.	(D)	(D)	(D)	(D)

ⓘ Note: The phone can be powered either from the network (PoE: IEEE 802.3 af) or from a 5-V DC power adapter (for information on power consumption see page 97). Only use the 5-V DC power adapters listed below or an exact equivalent adapter approved by your local reseller.

snom Product Number

00001164

Power Rating

10.5 W 90-264V AC / 5.25V DC

Phone Initialization

After your phone has been powered up, the system boots up and performs the following steps:

(1) Hardware Self-Test

A phone *hardware self-test* is run, all LEDs light up.

(2) TFTP Update Screen

The *TFTP Update Screen* allows you to update the firmware along with setting the phone back to factory values.

snom 300	snom 320	snom 360	snom 370
<p>⚠ Warning: Use this option only when the phone is malfunctioning on reboot. All settings will be lost and the phone is set back to factory values!</p>			
For TFTP update: Press any key: 3	For TFTP update: Press any key: 3	For TFTP update: Press any key: 3	For TFTP update. Press any key: snom VoIP phones © 2000-2007 snom technology ...
<p>📖 Read the instructions⁵ provided in our online knowledge database</p>			

(3A) Automatic Phone Initialization

The phone continues the initialization process by loading the last saved configuration.

snom 300	snom 320	snom 360	snom 370
System booting. Please wait...	System is booting up. Please wait...	System is booting up. Please wait...	System is booting up. Please wait snom VoIP phones © 2000-2007 snom technology ...

(3A-a) DHCP Request

By default the phone attempts to contact a **DHCP[®] Server** in your network in order to obtain its valid network settings, e.g. IP address, netmask, gateway, DNS server, etc. The message “Sending DHCP request” is displayed briefly and the obtained IP address and the phone’s MAC address are displayed.

snom 300	snom 320	snom 360	snom 370
IP-Adr: 192.168.X.X ⁷	IP-Adr: 192.168.X.X	IP-Adr: 192.168.X.X	IP-Adr: 192.168.X.X
MAC: 0004132XXXXX	MAC: 0004132XXXXX	MAC: 0004132XXXXX -----	MAC: 0004132XXXXX -----

① Note: If your network does not use DHCP, proceed to chapter “(3M-a) Manual DHCP Setup” on page 14.

(3A-b) Mass Deployment

A mechanism called **mass deployment** can be used to fully customize your phone automatically.

① Note: If your IP telephony system supports automatic initialization but any of the previously described steps have failed, inform your system administrator.

 For further information regarding mass deployment read the [instructions⁸](#) provided in our online knowledge database.

(3M) Manual Phone Initialization

If your IP telephony system does not support automatic initialization, use the following instructions.

(3M-a) Manual DHCP Setup

If your phone cannot contact a DHCP Server for any reason, the message “Sending DHCP requests” is displayed permanently.

Action: Stop the phone from sending DHCP requests

snom 300	snom 320	snom 360	snom 370
Send. DHCP rqst ■■■■■■■	Sending DHCP requests ■■■■■■■	Sending DHCP requests □□□□□□□□□□□□□□	Sending DHCP requests □□□□□□□□□□□□□□
Press		<input type="checkbox"/> Cancel	

Result: Sending of DHCP requests will be stopped and you will be prompted:

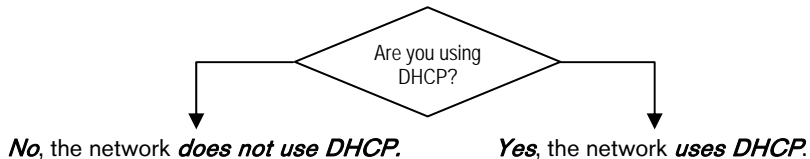

No, the network *does not use DHCP.*

Yes, the network *uses DHCP.*

① **Note:** Try to fix the problem which caused DHCP failure and proceed.

Press for not using DHCP

Press for using DHCP

Result: The phone will prompt you to enter the network settings manually.

Result: The phone reboots and attempts again to contact a DHCP server within your network to receive valid network settings.

⚠ Warning: Using the wrong network parameters may result in inaccessibility of your phone and may also have an impact on your network performance! Please ask your network administrator!

(3M-b) Manual Basic Configuration

When mass deployment is not used or incomplete, you will be prompted to enter the basic configuration manually.

Phone User Interface Language

Action: The default phone user interface language is “English”. Choose your preferred phone user interface language.



snom 300	snom 320	snom 360	snom 370												
Firmware Versions below 7 provide integrated multiple language support.			Not applicable												
<p>ⓘ Note: Since Firmware Version 7 additional languages can only be provided via mass deployment.</p> <p>📖 For further information read the instructions⁹ provided in our online knowledge database</p>			Integrated multiple language support												
<div style="border: 1px solid black; padding: 5px; width: fit-content;"> Sel. Language: English </div>	<div style="border: 1px solid black; padding: 5px; width: fit-content;"> Select Language ← English → </div>	<div style="border: 1px solid black; padding: 5px; width: fit-content;"> Select Language: English Suomi Frances Italiano </div>	<table border="1" style="width: 100%; border-collapse: collapse;"> <thead> <tr> <th style="width: 80%;">Language</th> <th style="width: 20%;">time</th> </tr> </thead> <tbody> <tr> <td>English</td> <td></td> </tr> <tr> <td>Suomi</td> <td></td> </tr> <tr> <td>Francais</td> <td></td> </tr> <tr> <td>Italiano</td> <td></td> </tr> <tr> <td>...</td> <td></td> </tr> </tbody> </table>	Language	time	English		Suomi		Francais		Italiano		...	
Language	time														
English															
Suomi															
Francais															
Italiano															
...															
<p>Use for navigation and select your preferred language from the list.</p> <p>Press to confirm your choice.</p>															

Result: The selected phone user interface language will be used for all following dialogs.

Tone Scheme (Dialtone)

This setting determines country-specific call progress tones, e.g. dial tone, busy signal, etc.

Action: Choose the country tone scheme (Australia ... USA)



snom 300	snom 320	snom 360	snom 370
Sel. Dialtone: Australia	Select Dialtone ← Australia →	Select Dialtone: Australia China Denmark France	Dialtone time Australia China Denmark France ...
<p>Use  for navigation and select your country's tone scheme from the list.</p> <p>Press  to confirm your choice.</p>			

Result: The tone scheme has been configured.

Time zone

This setting determines the correct display of the time including daylight saving time (DST) switching.

Action: Choose the time zone of your country / area (-10 ... +13)

snom 300	snom 320	snom 360	snom 370
Select Time Zone -10: USA (Honolu)	Select Time Zone ← -10: USA (Honolulu) →	Select Time Zone: -10: USA (Honolulu) -9: USA (Anchorage) -8: Canada (Vancouver)	Time Zone time -10: USA (Honolulu) -9: USA (Anchorage) -8: Canada (Vancouver) ...
<p>Use  for navigation and select your country's time zone from the list.</p> <p>Press  to confirm your choice.</p>			

Result: The time zone has been configured.

(3M-c) Logon Wizard

The “Logon Wizard” screen is shown when no extension (SIP identity) has been configured yet.

Action: Enter the Logon Wizard

snom 300	snom 320	snom 360	snom 370
This step is skipped.	This step is skipped.		
Press a key.			

Result: The “Logon Wizard” will guide you through the manual configuration steps for setting up your first extension (SIP identity).

Note: Please use the logon information provided by your system administrator or Internet Telephony Service Provider (ITSP).

For further information read the [instructions](#)¹⁰ in our online knowledge database.

Account (SIP username)

This setting determines the **account** that is part of the SIP address format (SIP- URI¹¹: “account@registrar”).

Action: Enter the **account** (SIP username) of the first extension (SIP identity)

snom 300	snom 320	snom 360	snom 370
Change the input mode, if applicable, and enter the first extension’s user name			
<p>Note: Acceptable entries are digits or letters, e.g. 100, turner, smith1, etc.</p>			
Confirm with <input checked="" type="checkbox"/>			

Result: The account of the first extension has been configured.

Registrar (SIP domain)

This setting determines the **registrar** that is part of the SIP address format (SIP- URI: "account@registrar").

Action: Enter the **registrar** (SIP domain) of the first extension (SIP identity)

snom 300	snom 320	snom 360	snom 370
Change the input mode, if applicable, and enter the first extension's registrar.			
<p>Note: Acceptable entries are domain names or IP addresses, e.g. sip.company.com, 192.168.0.100, etc.</p>			
Registrar: 192.168.0.100	Registrar: 123 192.168.0.100	----- Registrar ----- 192.168.0.100 ----- abc ABC C ← →	Registrar time 192.168.0.100 ----- abc a>>A C<< << >>
Confirm with <input checked="" type="checkbox"/> or abort with <input type="checkbox"/>			

Result: The registrar of the first extension has been configured.

Registration

The phone attempts to register the first extension (SIP identity) using the account/registrar data provided by the automatic or manual initialization.

① **Note:** Should the IP PBX (SIP registrar) require an *authentication*, you will be prompted to enter the correct *password*. Make sure you are using the appropriate input mode or enter the password via the web user interface, see page 38.

If the password is not accepted by the SIP registrar, you will be asked a second time to enter the password. If this is also not accepted, the registration process will be terminated for security reasons.

The registration status is shown on the idle screen (see page 93). The complete status message sent by the SIP registrar in plain text can be evaluated on the web user interface:

☰ Status → System Information → SIP Identity Status

Example:

Identity 1 Status: smith1@sip.company.com: **OK** or

Identity 1 Status: 100@sip.company.com: **Authentication failed** or

Identity 1 Status: 100@192.168.0.100: **Not found**

Successful Registration

The first extension (SIP identity) has been registered successfully and will be used for outgoing calls. This is displayed on the idle screen as follows:

snom 300	snom 320	snom 360	snom 370

Unsuccessful Registration

If the first extension (SIP identity) could not be registered the displays shows:

snom 300	snom 320	snom 360	snom 370
NR = Not registered	NR = Not registered		
① Note: If the registration fails contact your network administrator.			

Idle Screen

The idle screen is always shown on the display when there is no activity, i.e. no incoming/outgoing/active calls, etc. For further details see page 93.

Default Idle Screen

The default idle screen appears as shown below:

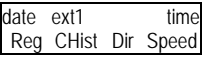
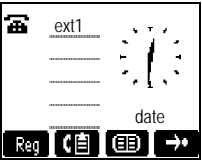
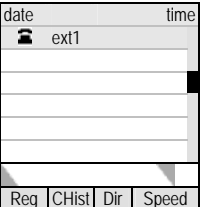

snom 300	snom 320	snom 360	snom 370
			

Customized Idle Screen

The idle screen can be customized.

Display Text

The display text determines the appearance of extensions (SIP identities) on the idle screen and will be displayed instead of the SIP URI:

snom 300	snom 320	snom 360	snom 370
 Setup → Identity X → Login → Display Text for Idle Screen: <Your Idle Screen Text>			
 Note: Text exceeding the maximum available space will be truncated.			

Context-Sensitive Function Keys

Snom 320, 360, and 370 only: The functionality of the context-sensitive keys (see page 8 and 91) for the idle screen can be changed:

snom 300	snom 320	snom 360	snom 370
Not supported	See page 91 for available functions:  Setup → Function Keys: S1...S4. Default setting:		
	<input type="radio"/> Reg	<input type="radio"/> CHist	<input type="radio"/> Dir <input type="radio"/> Speed

XML Idle Screen

snom 360 and 370 only: The position of the analog or digital clock, SIP identities, etc. can be defined in XML files, one each for each SIP identity. By changing the identity for outgoing calls (see page 53) the predefined XML file will be loaded and the idle screen appearance will change accordingly.

Note: The usage of this functionality requires a web server.

For further information read the [instructions](#)¹² in our online knowledge database.

snom 300	snom 320	snom 360	snom 370
Not supported	Not supported	 Setup → Identity X ¹³ → Login Tab → Login Information → XML Idle Screen URL: <URL>, e.g. http://myserver/screen1.xml	

User Interfaces

Phone User Interface

Menu Structure

The phone user interface provides access to the following three-level menu structure (**Level 1**, **Level 2**, and **Level 3**) in order to perform changes to the phone configuration.

Note: This menu structure *only* refers to *firmware release 7!*

snom 300	snom 320	snom 360 - snom 370
Call Forwarding * Off Time Timeout Target / Call Fwd Time Always Enter Always Target Busy Enter Busy Target	Call Forwarding S1 * Off S2 Time Timeout Target / Call Fwd Time S3 Always Enter Always Target S4 Busy Enter Busy Target	1 Display 1 Contrast Change Contrast 2 Display Method Only Name / Only Number / Name + Number / Number + Name / Show Full Contact 3 Backlight *On / Off / Always
Phone Behavior CWI *On / Off FKKeys Select Function Key / Key Type / Number	Phone Behavior S1 CWI *On / Off S4 FKKeys Select Function Key / Key Type / Number	2 Ring Tone 1 Choose Reg / Ring Tone 3 Audio 1 Headset Device *Off / On 2 MWI Notification Beep / Reminder / Silent
General Settings Contrast Select Contrast Lang Change Language	General Settings S1 Contrast Select Contrast S4 Lang Change Language	4 Preferences 1 Language Select Language 2 Time Zone Select Time Zone 3 Tone Scheme Select Tone Scheme by country
Headset Device * Off / On Volume Settings Hand Change Volume Head Change Volume Speaker Change Volume	Configuration S1 Reg Presence Ringer S2 Reset Resets the phone S3 Reboot Reboots the phone S4 DHCP DHCP Setup	

snom 300	snom 320	snom 360 - snom 370
Other Settings	Headset Device	5 Identity
TimeZone	S1 *Off / S2 On	1 Outgoing Identity
Select Timezone		Select ID for outgoing calls
DialTone	Volume Settings	2 Reregister User
Select Dialtone	S1 Hand	Select ID for reregistering
	Change Volume	3 Edit User
Web Interface	S2 Head	Select ID → Edit "Account" → Edit "Registrar"
Server	Change Volume	4 Logoff User
*HTTP & HTTPS / Off / HTTP Only / HTTPS Only	S4 Speaker	Select ID for logging off
HTTP	Change Volume	5 Logoff All
HTTP Port		Log off all IDs?
HTTPS	Other Settings	6 Phone Behavior
HTTPS Port	S1 TimeZone	1 Hide own outgoing ID
	Select Timezone	On / *Off
VLAN Settings	S4 DialTone	2 Reject anonymous
ID	Select Dialtone	On / *Off
Enter VLAN ID	Web Interface	3 Auto Dial
Priority	S1 Server	*Off / after 2,5,10,15 Sec.
Enter VLAN Priority	*HTTP & HTTPS / Off / HTTP Only / HTTPS Only	4 Auto Answer Indication
Reset	S2 HTTP	On / *Off
Resets VLAN Settings	HTTP Port	5 Auto Answer Type
	S4 HTTPS	Handsfree / Handset
System Info	HTTPS Port	6 Call Completion
Network	VLAN Settings	On / *Off
Displays Network Info	S1 ID	7 Number Guessing
Memory	Enter VLAN ID	On / *Off
Displays Memory Info	S2 Priority	8 Call Waiting
	Enter VLAN Priority	On / Visual Only / Ringer / Off
Configuration	S4 Reset	9 Deny All
Reg → Select Reg / Edit	Resets VLAN Settings	On / *Off
Presence → Edit	System Info	7 Call Forwarding
Ringer → Edit	S1 Network	1 Call Forwarding event
Reset	Displays Network Info	Never / Always / When Busy / On Timeout
Resets the phone	S4 Memory	2 Call Forwarding time
Reboot	Displays Memory Info	Enter Timeout (sec) "On Timeout"
Confirm to reboot the phone		3 Always target
DHCP		Enter target number "Always"
DHCP Setup		4 Busy target
		Enter target number "When Busy"
Information		5 Timeout target
IPAdr		Enter target number "On Timeout"
Displays IP Address		
MAC		
Displays MAC Address		
Version		
Displays Version		



snom 360 - snom 370

8 Network
1 DHCP
<i>DHCP Setup</i>
2 IP Address
<i>Enter IP Address</i>
3 Netmask
<i>Enter Netmask</i>
4 Hostname
<i>Enter Hostname</i>
5 IP Gateway
<i>Enter IP Gateway</i>
6 DNS Domain
<i>Enter DNS Domain</i>
7 DNS Server1
<i>Enter DNS Server 1</i>
8 DNS Server2
<i>Enter DNS Server 2</i>
9 NTP Server
<i>Enter NTP Server</i>
10 Webservice Type
<i>*HTTP & HTTPS / Off / HTTP Only / HTTPS Only</i>
11 HTTP Admin
<i>Enter HTTP Admin</i>
12 HTTP Password
<i>Enter HTTP Password</i>
13 Settings Server
<i>Enter Settings Server URL</i>
14 VLAN ID (0-4095)
<i>Enter VLAN Identity</i>
15 VLAN Priority (0-7)
<i>Enter VLAN Priority</i>
16 Reset VLAN

9 Key Mapping
1 Select Key → Key Type → Number
10 Maintenance
1 User / Administrator Mode
2 Net Info
<i>Displays Network Info</i>
3 Mem Info
<i>Displays Memory Info</i>
4 Reboot
<i>Confirm to reboot the phone</i>
5 Reset Values
<i>Resets the configuration</i>

Settings Menu

















Action: Enter the phone's "Settings Menu" to perform manual changes to your phone configuration.

snom 300	snom 320	snom 360	snom 370
Press 		Press 	

Result: The "Settings Menu" is shown on the display:

Call Forwarding *Off	← Call Forwarding → *Off TimeAlways Busy	1 2 Ringtone 3 Audio 4 Preferences	Settings time 1 Display 2 Ringtone 3 Audio 4 Preferences
-------------------------	---	---	--

Navigate through the different menu levels as follows:







snom 300	snom 320	snom 360	snom 370
<div style="border: 1px solid black; padding: 5px;"> <p>Level 1</p> <p>Level 2</p> </div> <p>Move through Level 1 by pressing</p> <p> or </p> <p>Move through Level 2 Level 3 by pressing</p> <p> or </p> <p>Enter Level 2 by pressing ✓</p>	<div style="border: 1px solid black; padding: 5px;"> <p>← Level 1 →</p> <p>Level 2</p> </div> <p>Move through Level 1 Level 2 Level 3 by pressing</p> <p> or </p> <p>Enter Level 2 by pressing</p> <p>   </p>	<div style="border: 1px solid black; padding: 5px;"> <p>1 Level 1</p> <p>2 Level 1</p> </div> <p>Move through Level 1 Level 2 by pressing</p> <p> or </p> <p>Enter Level 2 by pressing</p> <p></p> <p>Move through Level 3 by pressing</p> <p> or </p>	<div style="border: 1px solid black; padding: 5px;"> <p>Settings time</p> <p>1 Level 1</p> <p>2 Level 1</p> </div>
<p>The currently active setting is indicated as follows:</p>			
<p>Level 1 and Level 2: *active</p> <p>Level 3: First displayed menu item</p>		<p>active</p> <p>active</p> <p>Level 3: First displayed menu item</p>	
<p>Press  to save the changes or press  to abort.</p>			

Web User Interface

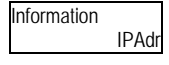
The symbol  indicates the use of the web user interface to change settings or operate your phone. You can use the web browser of any computer attached to your network.

Access

Action: Look up your phone's IP address

snom 300	snom 320	snom 360	snom 370
<p>Press</p>  then  <p>Information IPAdr</p> <p>Press </p> <p>IP Adr: 192.168.0.10</p>	<p>Press</p>  <p>Help</p> <p>Information IPAdr MAC Version</p> <p>IPAdr</p> <p>Press </p> <p>IP Adr: 192.168.0.10</p>	<p>Press</p>  <p>Help</p> <p>About</p> <p>snom 360-SIP-X.X.X IP Adr: 192.168.0.10 MAC: 00041323XXXX</p>	<p>Press</p>  <p>Help</p> <p>Info time</p> <p>snom 370-SIP-7.X.X IP Adr: 192.168.0.10 MAC: 00041326XXXX</p>

Result: The IP address of your phone is displayed, e.g. 192.168.0.10

Action: Access the web user interface of your phone

snom 300	snom 320	snom 360	snom 370
<p>Open the web browser of your computer. Enter the IP address in the browser's address bar: "http://<IP Address>" or "<IP Address>", e.g. "http://192.168.0.10" or "192.168.0.10". Confirm.</p>			

Result: The phone's web user interface page is displayed in the web browser window.

Page Headline
<p><Menu></p> <p>Menu Level 1</p> <p>Menu Level 2</p>

Configuration Settings
<p>tab tab tab</p> <p>section(s)</p> <p>setting <value> ?<Online Help></p> <p>...</p> <p>setting <value> ?<Online Help></p> <p>Save</p>

The *menu* is located on the left side; the *configuration of the settings* is done in the window on the right. Settings are grouped in *sections and/or tabs*. For further details press the "?" icon next to the setting. You will be forwarded to the appropriate description

of the setting's function in our online knowledge database.

Phone Configuration Changes

Warning: Before you change the settings of the standard configuration, read about the possible impact of your changes by clicking on the “?” icon behind each setting to call up our online knowledge database or search it manually at

<http://snom.com/wiki>

Action: Navigate the web user interface, change configurations, and save changes

snom 300	snom 320	snom 360	snom 370
<p>The following syntax will be used throughout this manual:</p> <ul style="list-style-type: none"> ☰ Menu Level 1 → Menu Level 2 → Tab/Section → Setting: <Value>, e.g.: ☰ Setup → Identity 1 → SIP → Proposed Expiry: <1 Day> <p>You have to save the configuration before the setting change takes effect by clicking on the Save button located at the bottom of each page</p>			
<p>Note: Some setting changes require a reboot of your phone (see page 51)</p>			

Phone Configuration

General Configuration Tasks

Language

The default phone and web user interface language is "English". You can change the *language* for the phone user interface and the web user interface independently from each other.

snom 300	snom 320	snom 360	snom 370
<i>Firmware Versions below 7</i> provide integrated multiple language support for both phone ¹⁴ and web ¹⁵ user interface			Not applicable
<p>① Note: <i>Since Firmware Version 7</i> additional languages can only be provided via mass deployment¹⁶.</p> <p>📖 For further information read the instructions provided in our online knowledge database.</p>			Integrated multiple language support for both phone and web user interface

Phone User Interface Language

Action: Change the language of the phone user interface

snom 300	snom 320	snom 360	snom 370
<p>📞 Setup → Preferences → General Information → Language: <Your Language></p> <p style="text-align: center;">or</p> <p>📞 General Settings → Language 📞 Preferences → Language</p>			

Result: The language of the phone user interface has been changed.

Web User Interface Language

Action: Change the language of the web user interface



snom 300	snom 320	snom 360	snom 370
<p>📞 Setup → Preferences → General Information → Web Interface Language: <Your Language></p>			

Result: The language of the web user interface has been changed.

Time and Date

If the **time zone** has been set correctly, the correct time and date for your time zone will be displayed, automatically taking daylight saving time, if applicable, into consideration.

Action: Change the current time zone

snom 300	snom 320	snom 360	snom 370
 Setup → Advanced → Network → Time → Time zone: <Your Timezone> or  Other Settings → TimeZone		 Preferences → TimeZone	

Result: The current time zone has been changed and the correct time is displayed.

Note: If the time (analog or digital clock) is not displayed at all, check the accessibility of the NTP time server:

 Setup → Advanced → Network → Time → NTP Time Server: <NTP Time Server>

Keyboard Lock

You can lock the keypad of your phone when you are temporarily not using it. This function helps you to protect your phone from unauthorized use.



Note: The following settings, if desired, must be made before lock activation:

 Setup → Preferences → Lock Keyboard → Emergency numbers: <1> <2> ...<X>

 Setup → Preferences → Lock Keyboard → PIN to unlock: <PIN>

Locking



Action: Activate the keyboard lock

snom 300	snom 320	snom 360	snom 370
Press  until the  symbol is displayed.			

Result: The keyboard lock is activated. Only set emergency numbers can be dialed.

Unlocking

Action: Deactivate the keyboard lock



snom 300	snom 320	snom 360	snom 370
Press  until the  symbol disappears from the idle screen. If a "PIN to unlock" has been set, you are prompted for the PIN.			

Result: The keyboard lock is deactivated.

Display Format

The display format determines how extensions are shown to callers and phones being called.

Action: Change the display format

snom 300	snom 320	snom 360	snom 370
 Setup → Preferences → General Information → Number Display Style:			
<Full Contact>:	The complete SIP-URI is shown		
<Name>:	Only the SIP display name is displayed		
<Number>	Only the number is displayed		
<Name+Number>	Name and number are displayed		
<Number+Name>	Number and name are displayed		
Example: The SIP-URI "John Smith" <sip:100@sip.company.com> will be displayed as:			
<Full Contact>:	"John Smith" <sip:100@sip.company.com>		
<Name>:	John Smith		
<Number>	100		
<Name+Number>	John Smith 100		
<Number+Name>	100 John Smith		
		or	
 Display → Display Method			











Result: The display format of extensions is changed.

Display Configuration Tasks

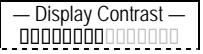
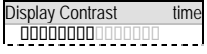
Display Contrast

You can adjust your phone's display contrast.

Action: Change the display contrast:

snom 300	snom 320	snom 360	snom 370
<p> Enter the settings menu and navigate through the menu (see page 22):</p>			
<p> General Settings → Contrast</p>		<p> Display → Contrast</p>	
<p>The "Display Contrast" bar is shown on the display:</p>			
			
<p>Press   to reduce or   to increase the contrast</p>			
<p>Press ok  to save the contrast change (or press  to abort).</p>			







Result: The display contrast has been changed.

Backlight Mode

You can adjust the display's backlight mode. By default the backlight mode is "On":

- **On:** Backlight is turned off or dimmed when the phone is inactive for approximately 20 seconds
 - snom 360: Backlight is turned off completely.
 - snom 370: Backlight is dimmed.
- **Off:** Backlight is turned off completely
- **Always:** Backlight is on permanently.

Action: Change the backlight mode.

snom 300	snom 320	snom 360	snom 370
Not applicable	Not applicable	<p> Enter the settings menu (see page 25) and navigate through the menu (see page 22):</p> <p> Display → Backlight</p> <div style="display: flex; justify-content: space-around; border: 1px dashed black; padding: 5px;"> <div style="border: 1px solid black; padding: 2px;">Backlight On</div> <div style="border: 1px solid black; padding: 2px;">Backlight time On</div> </div> <p>Change the backlight mode by pressing</p> <div style="text-align: center;">  or  </div> <p>Press  to save the backlight mode or press  to abort.</p> <p style="text-align: center;">or</p> <p> Setup → Preferences → General Information → Use Backlight: <On> / <Off> / <Always></p>	















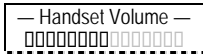
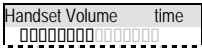

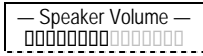
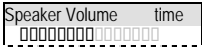
Result: The backlight mode has been changed.

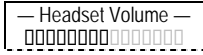
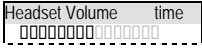
Audio Configuration Tasks

Volume

You can adjust the volume of the currently used audio device when the phone is in “dialing” mode (see page 57) or during an active call (see page 71).

Action: Adjust the volume of the active audio device.

snom 300	snom 320	snom 360	snom 370	
Press  				
When <i>handset mode</i> is activated the following screen appears in the display:				
				
When <i>handsfree mode</i> is activated the following screen appears in the display:				
				
When <i>headset mode</i> is activated the following screen appears in the display:				
				
Decrease volume   Increase volume				
-	or press  S1		or press  S4	
	or press  S1		or press  S4	
Press  to save the change or press  to cancel.				

Result: The volume of the active audio device has been adjusted.





Headset Use

Physically connect your headset (see page 11) and activate/deactivate it for use.

If you are using a wireless headset and the snom [wireless headset adapter](#)¹⁷, the wireless mode is automatically activated.

Activation

Action: Activate the headset mode before making or answering a call

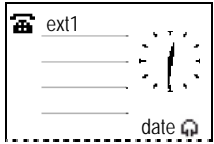
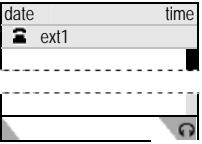

snom 300	snom 320	snom 360	snom 370
<p> Setup → Preferences → General Information → Use Headset Device: <On></p> <p>or</p> <p> Enter the settings menu (see page 25) and navigate through the menu (see page 22):</p> <p> Headset Device → On</p>		<p>Press</p> <p>Headset </p>	

Result: Headset mode has been activated. This is indicated on the display as follows:

	Headset symbol is displayed during a call only		
---	--	--	--

Deactivation

Action: Deactivate headset mode

<p> Headset Device → On</p>	<p>Press again</p> <p>Headset </p>
--	---

Result: Headset mode has been deactivated.

Ringtones

Ringtones are used to indicate incoming calls (see page 63).

Mapping

Different methods with different priorities (1 = highest priority, 5 = lowest priority) are used to assign a ringtone to an incoming call:

Only for advanced users or system administrators:

1. SIP Header „Alert-Info“ contains URL of a **custom melody ringtone file**
 Setup → Advanced → Audio → *Alert-Info playback*: <ON>
2. SIP- Header „Alert-Info“ refers to **10 built-in ringtones + Silent**
 Setup → Preferences → Alert-Info Ringer →
 - a) *Alert Internal / External / Group Text*: <Text used in “Alert-Info” to assign a ringtone to internal / external / group calls>
 - b) *Alert Internal / External / Group Ringer*: <Ringer 1-10; Silent>

For phone users:

3. Contact types in the directory (see page 81) can be mapped to
 → **10 built-in ringtones + Silent + 1 custom melody ringtone**
 Setup → Preferences →
Directory Ringtones: <Ringer 1-10; Silent; Custom Melody URL>
 Setup → Preferences →
Custom Melody URL: < URL to a WAV file on a HTTP(S) server >
4. Each extension (SIP Identity) can be mapped to
 → **10 built-in ringtones + Silent + 1 custom melody ringtone**
 Setup → Identity X → Login → Login Information →
Ringtone: <Ringer 1-10; Silent; Custom Melody URL>
 Setup → Identity X → Login → Login Information →
Custom Melody URL: <URL to a WAV file on a HTTP(S) server>
5. Default ringtone can be mapped to **10 built-in ringtones+ Silent**
 Setup → Preference → Ringtone defaults → *Default Ringer*: <Ringer 1-10; Silent>







① Note: Users are recommended to map ringtones either to different extensions (4) or different contact types in the directory (3).

The default ringtone (5) should be played only when the phone cannot identify an incoming call as either (3) or (4).

Custom melody ringtones are mono WAV files using PCM at 8 kHz with 16 bit/sample (linear). Sample files are available for download at <http://snom.com/download/melodyX.wav> (X=1-8)

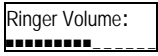
Volume

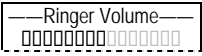
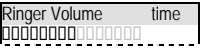













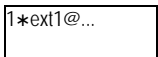

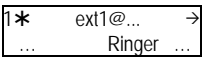

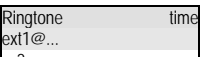
Action: Adjust the volume of the ringtone assigned to the extension (SIP identity) currently active for outgoing calls.

snom 300	snom 320	snom 360	snom 370
When the phone is in idle mode, press   .			
			
Decrease volume   Increase volume			

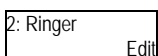
Result: The volume of the ringtone has been adjusted.

Playback

Action: Play back the ringtone assigned to your extension X (SIP identity X).

snom 300	snom 320	snom 360	snom 370
 Setup → Identity X → Login → Login Information Play the ringtone by pressing Play Ringer			
or			
 Enter the settings menu and navigate through the menu (see page 22):			
 Configuration → Reg		 2 Ringtone	
Press  	Press  S1 	Press  	
Use  or  to choose the extension X ²³ whose ringtone you want to change.			
Press 2x  	Press  S3 	Press  	
Press 			

Result: The ringtone is played back.

Configuration



Action: Change the ringtone assigned to your extension X (SIP identity X).

snom 300	snom 320	snom 360	snom 370
<p>Select a ringtone from the list:</p> <p> Setup → Identity X → Login → Login Information → <i>Ringtone:</i> <Ringer 1-10; Silent; Custom Melody URL></p> <p>If you chose “custom melody URL”, specify location:</p> <p> Setup → Identity X → Login → Login Information → <i>Custom Melody URL:</i> <URL to a WAV file on a HTTP(S) server></p> <p>Verify the ringtone by pressing </p> <p>Save by clicking </p> <p>or</p> <p> Enter the settings menu (see page 25) and navigate through the menu (see page 22) until the following screen is displayed:</p> <div style="display: flex; justify-content: space-around;"> <div style="border: 1px solid black; padding: 5px; width: 15%;"> Ringtone Ringer 1 </div> <div style="border: 1px solid black; padding: 5px; width: 15%; text-align: center;"> Ringtone ← Ringer 1 → </div> <div style="border: 1px solid black; padding: 5px; width: 15%; text-align: center;"> Ringtone Ringer 2 </div> <div style="border: 1px solid black; padding: 5px; width: 15%; text-align: right;"> Ringtone Ringer 1 Ringer 2 time </div> </div> <p>You can listen to each ringtone by browsing through the list.</p> <div style="display: flex; justify-content: space-around;"> <div style="text-align: center;"> Press or </div> <div style="text-align: center;"> Press or </div> </div> <p>Press to save the changes (or press to abort).</p>			

Result: The ringtone has been changed; the new ringtone will be used for incoming call indication (see page 63) if no higher prioritized ringtone is assigned (see page 35).



SIP Identity Configuration Tasks

snom VoIP phones support multiple extensions (SIP identities). Each extension will act like a separate phone line in a conventional telephony system. As soon as the extensions have been registered (see page 19), calls can be placed from and received to these extensions.

snom 300	snom 320	snom 360	snom 370
4 extensions (SIP Identity 1...4)	12 extensions (SIP Identity 1...12)		
<p>① Note: We recommend using the web user interface to perform the following configuration changes as it is more convenient:  Setup → Identity X.</p> <p>Use only the logon information provided by your VoIP PBX administrator or Internet Telephony Service Provider (ITSP).</p> <p> For further information read the instructions¹⁸ in our online knowledge database.</p>			

Adding / Editing Extensions

Action: Add a new extension X / Edit existing extensions X

snom 300	snom 320	snom 360	snom 370
<p>Verify the status and availability of your extensions:  Status → System Information → SIP Identity Status</p> <p>Add / Edit the following identity information  Setup → Identity X → Login Tab → Login Information → <i>Account</i> (SIP Username), e.g. 100, turner, smith1, etc. <i>Password</i> (SIP Password) <i>Registrar</i> (SIP Domain/ Server), e.g. .company.com, 192.168.0.100, etc.</p> <p>Save your changes by clicking </p>			
<p>① Note: This action requires a reboot of your phone (see page 29)</p>			

Result: After the phone has rebooted a new extension has been added to your phone configuration which can be used to place or receive calls. See page 53.

Blocking Extensions

Action: Block an extension (SIP identity) temporarily

snom 300	snom 320	snom 360	snom 370
 Setup → Identity X → Login Tab → Login Information → Identity active: <OFF>			

Result: The chosen extension (SIP identity) is blocked for both outgoing and incoming calls. All configuration settings are kept unchanged.

Removing Extensions

This functionality is called “hot desking” and is regularly used in office environments (“mobility centers”) where not all the employees are in the office at the same time or not in the office for very long at all (see page 79).

Single Extension

Action: Remove single extension X (SIP Identity X)

snom 300	snom 320	snom 360	snom 370
 Setup → Identity X → Login Tab → Login Information → Remove identity			

Result: The selected extension will be removed from your phone configuration.

All Extensions

Action: Remove all SIP Identities

⚠ Warning: Removing all extensions (SIP identities) will immediately unregister all currently configured extensions (SIP identities) and delete their configuration data from the phone. The phone can no longer be used and must be initialized anew.

snom 300	snom 320	snom 360	snom 370
 Setup → Identity X → Login Tab → Login Information → Remove all identities			

Result: All extensions are unregistered and removed from your phone configuration. The phone is placed out of operation and by default the logon wizard (see page 17) will be shown on the display.

This behavior can only be disabled via [mass deployment](#)¹⁹: logon_wizard: OFF

Function Key Configuration Tasks

Various functionalities can be mapped onto the free function keys P_x (see page 7); the adjacent yellow LEDs show their current status.

snom 300	snom 320	snom 360	snom 370
6 free function keys P1...P6	12 free function keys P1...P12		
<p>Note: We recommend using the web user interface to program the free function keys as it is more convenient:  Setup → Function Keys → P_x</p>			

Input fields

Context

The default setting is <Active>, i.e., the functionality chosen under “Type” will be applied to any currently active extension (SIP identity) for outgoing calls (see page 53).

If a specific extension (SIP identity) is chosen from the pull down menu, the functionality under “Type” will be applied only to the chosen extension (SIP identity).

Type

The default setting is <Line>. When another setting is selected from the pull down menu “Types”, that functionality will be applied to the extension (SIP identity) chosen as “Context”. For further details see chapter “Key Types” below.

Number

The default setting is <blank>. You can enter a number / HTTP(S) URL / SIP URI as required by “Type”.

Key Types

The free function key “Types” *Line, Shared Line, Extension, Park Orbit, Voice Recorder, DTMF, Push2Talk, Intercom, Action URL, Key Event, Speed Dial, None* are explained in the following subchapters.

 For further [information and examples](#)²⁰ consult our online knowledge database

Line

- ① Dependencies:**
- *Context:* <SIP Identity> or <Active>
 - *Number:* <blank>

Description: This is the default key function. It is used to indicate and accept incoming calls and allows placing active calls on hold or resuming them. It can also be used to make a call using a specific extension (SIP identity)

Usage: An incoming call is indicated by the blinking LED of the first available free function “Line” key, whose “Context” is set to the extension (SIP identity) being called:

- Press a “Line” key to accept the call, see page 63 / 64.
- Press a “Line” key again to place the call on hold, see page 74
- Press a “Line” key again to resume the call, see page 74

Making a call:

- Press a “Line” key in idle state to select the extension (SIP identity) set under “Context” as the outgoing extension for this one call; for permanent selection see page 53

Shared Line

① Note: This feature must be supported by your VoIP PBX (currently available for PBXnSIP, Sylanro and Broadsoft)

- Dependencies:**
- *Context:* <SIP Identity>
 - *Number:* <BLA / SLA resource URI >

Description: This key function is used by the “Bridged or Shared Line Appearance (BLA or SLA)” feature which allows users to share SIP lines and also provides status monitoring of the shared line.

Usage: When a user places an outgoing call using such an appearance, all members belonging to that particular SLA group are notified of this usage and are blocked from using this line appearance until the line goes back to idle state or when the call is placed on hold.

Similarly all members of the SLA group are notified of an incoming call and the call can be picked up on a line appearance associated with the SLA extension.

SLA members can monitor the status of the bridged line via the LED adjacent to the free function “Shared Line” key:

- LED “on” indicates the line is in use
- LED “off” indicates an idle status.

 For further [information](#)²¹ consult our online knowledge database.

Extension (formerly "Destination")

- | | |
|------------------------|---|
| ① Dependencies: | <ul style="list-style-type: none">• <i>Context:</i> <SIP Identity>• <i>Number:</i> <monitored extension> |
|------------------------|---|

Description: This key function allows you to monitor the status (idle, ringing, or busy) of other extensions (SIP accounts) within your VoIP telephony environment and to pick up unanswered calls to those extensions. Additionally the "Speed Dial" and "Manual Call Forwarding" functionality is provided by this key function.

Usage:

- *Extension Monitoring & Call Pickup:* See the detailed description on page 89

① Note: Your VoIP PBX must support this function (RFC 4235 compliant)
--

- *Speed Dial Key:* Press an "Extension" key during idle state to dial the extension specified under "Number".
- *Manual Call Forwarding:* Press an "Extension" key to forward an incoming call to the extension specified under "Number" without answering it first.

Park Orbit

① Note: Your VoIP PBX must support this feature; a valid park orbit extension (SIP account) is required.

- | | |
|----------------------|--|
| Dependencies: | <ul style="list-style-type: none">• <i>Context:</i> <SIP Identity>• <i>Number:</i> <park orbit extension (SIP account)> |
|----------------------|--|

Description: This key function allows you to park a call on one phone and continue the conversation from any other phone.

Usage:

- *Call Parking:* Press a "Park Orbit" key to park an active call in the "park orbit" specified under "Number". The adjacent LED starts blinking on your phone (and on any other phones using the free function "Park Orbit" key).
- *Parked Call Pickup:* Press a "Park Orbit" key to pick up the parked call on any phone using this key function (adjacent LED is blinking). If several calls have been parked in the same "park orbit", the first or last call parked (depends on your VoIP PBX) can be picked.

Voice Recorder

① **Note:** Your VoIP PBX must support this feature; a valid voice recording extension (SIP account) is required.

Dependencies:

- *Context:* <SIP Identity>
- *Number:* <voice recorder extension (SIP account)>

Description: This key function allows you to record a conversation during an active call as well as short memos or minutes of a meeting when the phone is idle.

Usage:

- *Start Voice Recording:* Press a "Voice Recorder" key once to start sending the audio stream to the "voice recorder extension (SIP account)" specified under "Number". The adjacent LED lights up and the audio stream is recorded on your VoIP PBX.
- *Stop Voice Recording:* Press the key again to stop recording. The adjacent LED is turned off.
- *Listen to voice recordings:* You can listen to the recorded audio stream by calling the "voice recorder extension (SIP account)" specified under "Number".

DTMF

① **Dependencies:**

- *Context:* <SIP Identity>
- *Number:* <DTMF sequence> (allowed digits: "0-9", "*", "#", "A-D" and flash: "!"; for adding breaks use the character caret "^". Each "^" adds a break of 100 ms)

Description: This key function allows sending the specification of arbitrary key sequences via DTMF.

Usage: Press a "DTMF" key during an active call to send the key sequence specified under "Number" via DTMF.

Push2Talk

① **Note:** Your VoIP PBX must support this function.

The following settings must have been configured in advance:

Your phone:  Setup → Advanced → Behavior → *Enable Intercom*: <ON>

Other phones:  Setup → Advanced → Behavior → *Auto Answer Policy*: <Always>

Dependencies:

- *Context*: <SIP Identity> or <Active>
- *Number*: <extension>

Description: Similarly to the “Intercom” function, users can make intercom calls. This feature is particularly useful for group announcements.

Usage:

- *Enable Intercom mode:* Press this key to connect your phone directly to the extension specified under “Number”, if authentication has been set up properly. The adjacent LED lights up. ***The intercom call will remain active as long as the programmed key is pressed.***
- *Disable Intercom mode:* The intercom call will be terminated as soon as the free function “Push2Talk” key is released. The adjacent LED will be turned off.

Intercom

① **Note:** Your VoIP PBX must support this feature.

The following settings must have been configured in advance:

Your phone:  Setup → Advanced → Behavior → *Enable Intercom*: <ON>

Other phones:  Setup → Advanced → Behavior → *Auto Answer Policy*: <Always>

Dependencies:

- *Context*: <SIP Identity>
- *Number*: <extension>

Description: This key function enables the “Intercom” mode and is useful in an office environment as a quick access to connect to the operator or the secretary.

Usage:

- *Enable Intercom mode:* Press an “Intercom” key to connect your phone directly to the extension specified under “Number”, if authentication has been set up properly. The adjacent LED lights up.
- *Disable Intercom mode:* Terminate the intercom call as usual (see page 59)

Action URL

- | | |
|----------------------|--|
| Dependencies: | <ul style="list-style-type: none">• <i>Context:</i> <Active>• <i>Number:</i> < HTTP URL>• <i>LED:</i> inactive |
|----------------------|--|

Description: This key function allows you to send HTTP requests to a web server, e.g. you can set a status on the server or retrieve Minibrowser (see page 83) applications.

Usage: Press an “Action URL” key to send the HTTP URL specified under “Number” to the web server.

 For further [information](#)²² consult our online knowledge database.

Key Event

- | | |
|----------------------|---|
| Dependencies: | <ul style="list-style-type: none">• <i>Context:</i> <SIP Identity> or <Active>• <i>Number:</i> <key event short cut> |
|----------------------|---|

Description: Key events are predefined shortcuts to phone and call functions. See the complete mapping on page 93.

Usage: Press a “Key Event” key to call the predefined function of the shortcut specified under “Number”.

Speed Dial

- | | |
|----------------------|---|
| Dependencies: | <ul style="list-style-type: none">• <i>Context:</i> <SIP Identity> or <Active>• <i>Number:</i> <extension> |
|----------------------|---|

Description: This key function allows you to speed up dialing numbers often used or hard to remember. As opposed to key type “Extension”, this key type does not provide “Extension Monitoring & Call Pickup”

Usage: Press a “Speed Dial” key to call the extension specified under “Number”.

None

Description: This key function provides no functionality.

Maintenance Tasks

Administrator Password

⚠ Warning: You need to know the administrator password to return to administrator mode; otherwise you have to perform a reset to factory values! All current setting changes will be lost! Use the following URL to reset the phone:

🌐 <http://<IPAddress>/advanced.htm?reset=Reset>

Action: Change the Administrator Password via Web user interface

snom 300	snom 320	snom 360	snom 370
🌐 Setup → Advanced → QoS/Security → Administrator Password: <Your Password> 🌐 Setup → Advanced → QoS/Security → Administrator Password (Confirmation): <Your Password>			
Save by clicking on <input type="button" value="Save"/>			

Result: The administrator password has been changed.

Operation Modes

The default operation mode is “Administrator Mode”.

User Mode

User Mode limits the configuration rights, i.e. no access to parts of the menus on both web and phone user interface.

Action: Enable *User Mode* via Web or Phone User Interface



snom 300	snom 320	snom 360	snom 370
🌐 Setup → Advanced → QoS/Security → Administrator mode: <OFF> Save by clicking on <input type="button" value="Save"/>			
or			
not supported	not supported	📞 Enter the settings menu and navigate through the menu (see page 22): 📞 10 Maintenance → 1 User Mode Press <input type="button" value="✓"/>	

Result: User Mode has been enabled.

Administrator Mode

Administrator mode grants unlimited access to the phone configuration on both web and phone user interface.

Action: Enable administrator mode via web user interface or phone user interface

snom 300	snom 320	snom 360	snom 370
 Setup → Advanced → Enter Administrator Password Save by clicking <input type="button" value="Save"/>			
not supported	not supported	or  Enter the settings menu and navigate through the menu (see page 22):  9 Maintenance → 1 Administrator Mode Press <input type="button" value="✓"/> <div style="display: flex; justify-content: space-around; border: 1px solid black; padding: 5px;"> <div style="border: 1px solid black; padding: 2px;">— Admin Mode Pwd —</div> <div style="border: 1px solid black; padding: 2px;">Admin Mode Pwd <input type="text" value="time"/></div> </div> Enter the administrator password and press <input type="button" value="✓"/>	

Result: Administrator Mode has been enabled.

Firmware Update

The phone is delivered with pre-installed software (firmware) which allows operating your phone flawlessly. If you require updating the phone's firmware you can acquire a new version at snom's website:

<http://snom.com/firmware.html> or <http://wiki.snom.com/Firmware>

Note: Only advanced users should conduct a firmware update. If your phone operates in a locally hosted VoIP PBX environment ask your system administrator.

Versions

Several major firmware versions have been released for snom phones:

snom 300	snom 320	snom 360	snom 370
	Release 3	Release 3	
	Release 4	Release 4	
	Release 5	Release 5	
Release 6	Release 6	Release 6	
Release 7	Release 7	Release 7	Release 7

Methods

Firmware updates can be conducted using the following methods:

Only for advanced users or system administrators:

1. **Manual TFTP update:** Exceptional situations or downgrade, see page 12
2. **Manual update/downgrade:** Most convenient when updating/downgrading within the same major release level, e.g. 6.X: from version 6.2.3 to 6.5.10, etc.

Note: We do not recommend manual updates between different major release levels, e.g. from 3.X/4.X/5.X to 6.X or 6.X to 7.X. Use → automatic updates instead.

3. **Automatic update:** This method updates your phone firmware to the current official release.

Manual update or downgrade

Note: This method requires an internet connection.

The manual update is conducted via the phone's web user interface.

Version Check

Action: Check the firmware version currently installed on your phone

snom 300	snom 320	snom 360	snom 370
<p> Status → System Information → System Information → <i>Firmware-Version:</i></p>			
<p>snom 300-SIP X.Y.Z snom 320-SIP X.Y.Z snom 360-SIP X.Y.Z snom 370-SIP X.Y.Z</p>			
or			
<p> Enter the settings menu and navigate through the menu (see page 22):</p> <p> Information → Version</p> <p>Press <input checked="" type="checkbox"/></p> <p>Version: s300-SIP X.Y.Z</p>		<p> Press</p> <p></p> <p>Help</p> <p>← Information → IPAdr MAC Version</p> <p>Version Press <input type="button" value="S4"/></p> <p>Version: snom 320-SIP X.Y.Z</p>	
		<p>----- About -----</p> <p>snom 360-SIP-X.Y.Z IP Adr: X.X.X.X MAC: 0004132XXXXX</p>	<p>Info time</p> <p>snom 370-SIP-X.Y.Z IP Adr: 192.168.0.10 MAC: 0004132XXXXX</p>

Result: The firmware version currently installed on your phone is displayed.

Version Comparison





Compare the major release level of the latest available firmware version published on [snom's firmware download website](#)²³ with the firmware version installed on your phone. If they differ you are strongly advised not to conduct a manual update!

Example: Latest available firmware version for snom 360 is **6.5.10**

- Snom 360 (1): Installed: snom 360-SIP **4.5** → use **automatic** update
- Snom 360 (2): Installed: snom 360-SIP **6.2.2** → **manual** update can be used

Firmware Update

Action: Conduct a manual firmware update

snom 300	snom 320	snom 360	snom 370
Navigate to snom's firmware download website			
Copy the link (URL) of the appropriate firmware version X.Y.Z by right-clicking on the "File" Symbol 			
Version	Type	File	Size
X.Y.Z	applications	 .bin	<File Size> MB
Access the phone's web user interface			
 Setup → Software Update → Manual Software Update Setup → <i>Firmware</i> and paste the link into the "Firmware" field.			
Start the update by clicking on 			
 The phone reboots automatically and you are prompted to confirm the update.			
Press <input checked="" type="checkbox"/> to confirm or press <input type="checkbox"/> to abort the update process.			
The phone loads the new software from snom's web server. This process may take some time depending on the <File Size> and the speed of your internet connection.			
⚠ Warning: Any power interruption during the following process will most likely lead to a flash memory error. As a result the system cannot boot up anymore and the phone must be sent in for repairing at your own expense.			
After successful download the old firmware is erased and the new firmware is written into the phone's flash memory.			
The phone reboots again and will be initialized using the previously stored phone configuration.			

Result: The firmware is updated. You can verify the successful update as described in chapter "Version Check" on page 48.

Automatic update

Note: This method requires an internet connection.

The automatic update is conducted via the phone's web user interface.

Action: Conduct an automatic firmware update

snom 300	snom 320	snom 360	snom 370
<p>Navigate to snom's online knowledge database and read this article²⁴ carefully.</p> <p>Copy the <i>link</i> of the appropriate update method (recommended "Update once to current official firmware release"):</p> <p>http://provisioning.snom.com/release/update_once.php</p> <p>Access the phone's web user interface (<i>below Version 7</i>):</p> <p>☰ Setup → Advanced → Update → <i>Setting URL</i> and paste the <i>link</i> into that field.</p> <p>Save the change by clicking on Save and start the update by clicking on Reboot</p> <p>☎ The phone reboots automatically</p>			
<p>Warning: Any power interruption during the following process will most likely lead to a flash memory error. As a result the system cannot boot up anymore and the phone must be sent in for repairing at your own expense.</p>			
<p>The phone automatically loads the necessary software from snom's web server successively. The whole update process may take some time.</p> <p>The phone will be initialized using the previously stored phone configuration.</p>			

Result: The firmware is updated. You can verify the successful update as described in chapter "Version Check" on page 48.

Reboot

Note: You should reboot the phone when you are challenged, e.g. after applying changes to the phone configuration.

Action: Reboot the phone.

snom 300	snom 320	snom 360	snom 370
Setup → Advanced → Update → Reboot			
or			
☎ Enter the settings menu and navigate through the menu (see page 22):			
☎ Configuration → Reboot		☎ 10 Maintenance → 4 Reboot	
Press <input checked="" type="checkbox"/>	Press <input type="button" value="Reboot"/>	Press <input checked="" type="checkbox"/>	
<input type="text" value="Reboot?"/>	<input type="text" value="Reboot?"/> <input type="button" value="Cancel"/>	<input type="text" value="---- Reboot ----"/> <input type="text" value="Reboot?"/>	<input type="text" value="Reboot time"/> <input type="text" value="Reboot?"/>
Press <input checked="" type="checkbox"/>			

Result: The phone reboots.

<input type="text" value="Rebooting..."/>	<input type="text" value="Rebooting..."/>	<input type="text" value="Rebooting..."/>	<input type="text" value="Rebooting..."/>
---	---	---	---

Factory Reset

① **Note:** You should reset the phone only in the following situations:

- The phone configuration was changed and the phone is not functioning anymore.
- The help desk of your vendor or snom partner advised you to do so.

Action: Reset the phone configuration to factory values

snom 300	snom 320	snom 360	snom 370
Enter the settings menu (see page 25) and navigate through the menu (see page 22) until the following screen is displayed:			
<p>☎ Configuration → Reset</p> <p>Press <input checked="" type="checkbox"/></p> <p>Admin Mode Pwd</p>		<p>☎ 10 Maintenance → 5 Reset Values</p> <p>Press <input checked="" type="checkbox"/></p> <p>Admin Mode Pwd time</p>	
<p>Press <input checked="" type="checkbox"/> Reset</p> <p>Admin Mode Pwd</p>		<p>Press <input checked="" type="checkbox"/></p> <p>Admin Mode Pwd time</p>	
<p>⚠ Warning: If you confirm by entering the admin password all current setting changes will be lost and your phone must be configured anew manually unless mass provisioning is used!</p>			
<p>Enter the administrator password and press <input checked="" type="checkbox"/></p>			

Result: The phone reboots and the phone configuration is resetted.

Rebooting...	Rebooting...	Rebooting...	Rebooting...
--------------	--------------	--------------	--------------

Basic Call Functions

Outgoing Calls

Extension (SIP identity) for Outgoing Calls

Example: There are two extensions (ext1, ext2) registered on your phone; “ext1” is currently used for outgoing calls.

Action: Select *ext2* for outgoing calls.

snom 300	snom 320	snom 360	snom 370

Result: The extension displayed will be used for outgoing calls.

Result: The extension indicated by ☎ will be used for outgoing calls.

Result: The highlighted extension (☎) will be used for outgoing calls.

Making Calls

You can make calls using the supported number formats described below. Change the input mode in accordance with the number format (see "Input Mode" on page 55). Use the appropriate audio operation mode (see page 57) for dialing.

Supported Formats

The following types of numbers/addresses can be dialed.

Phone Numbers

snom 300	snom 320	snom 360	snom 370
<p>Phone numbers; format is specified in E.164, e.g. 0049030398330 or +4930398330</p> <ul style="list-style-type: none"> Use the alphanumeric keys 1 to --0, see page 6. Use numeric input mode [123], see page 56 			

SIP Addresses (SIP-URI)

snom 300	snom 320	snom 360	snom 370
<p>SIP addresses; SIP-URI format is specified in RFC 3261, e.g. 123456@snom.com abcd@192.168.0.2 etc.</p> <ul style="list-style-type: none"> Use the alphanumeric keys 1 to --0, see page 6. Use numeric input mode [123], see page 56, and/or alphanumeric mode [abc / ABC], see page 55 			

IP Addresses

Note: We do not recommend the use of IP addresses.

snom 300	snom 320	snom 360	snom 370
<p>IP addresses; IPv4 specification, e.g. 192.168.0.2 etc.</p> <ul style="list-style-type: none"> Use the alphanumeric keys 1 to --0, see page 6. Use numeric input mode [123], see page 56 			





Input Mode

The default input mode is the **numeric** mode.

Note: Change the input mode in accordance with the type of number to be dialed. The last input mode will remain active.

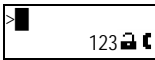
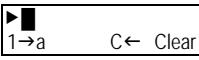
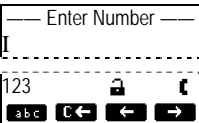
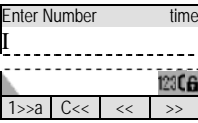
Numeric Mode to Alphanumeric Mode (Lower case)

Action: Change input mode from numeric to alphanumeric mode (lower case)



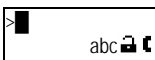
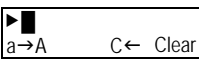
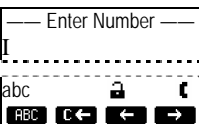
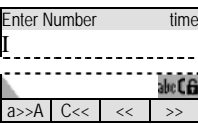

snom 300	snom 320	snom 360	snom 370
			
Press 	Press  1 → a S1	Press  abc S1	Press  1>a S1

Result: The input mode has been changed to **lower case**. The display shows:

			
---	---	---	---

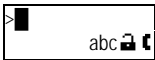
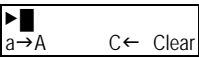
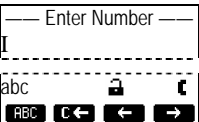
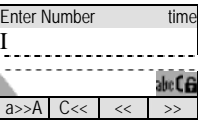
Lower Case to Upper Case

Action: Change input mode from lower to upper case

snom 300	snom 320	snom 360	snom 370
			
Press 	Press  a>A S1	Press  ABC S1	Press  a>A S1

Result: The input mode has been changed to **upper case**. The display shows:

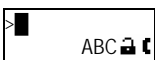
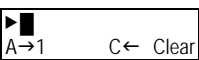
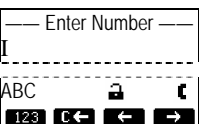
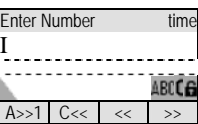
			
---	---	---	---







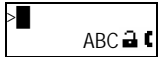

Action: Toggle between *lower case* and *upper case* input mode

snom 300	snom 320	snom 360	snom 370
Press 			

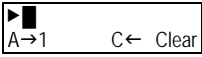
Result: The input mode is toggled between lower and upper case. The phone displays the current input mode.

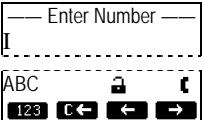
Alphanumeric Mode (Upper Case) to Numeric Mode

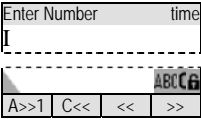
Action: Change input mode from alphanumeric (upper case) to numeric mode





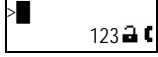
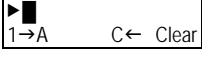
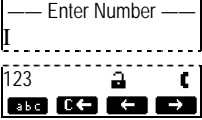
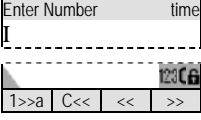

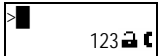
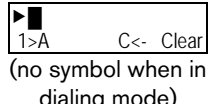
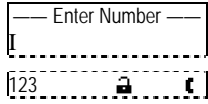
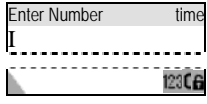

snom 300	snom 320	snom 360	snom 370
 <p>Press </p>	 <p>Press  S1</p>	 <p>Press  S1</p>	 <p>Press  S1</p>

Result: The input mode has been changed to *numeric*. The display shows:

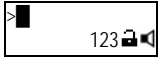
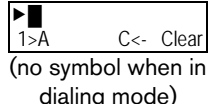
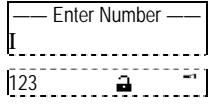
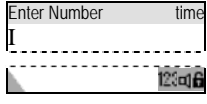
			
---	---	---	---

Audio Operation Mode

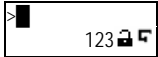
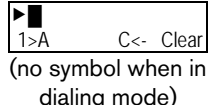
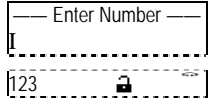
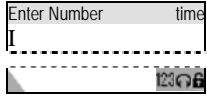
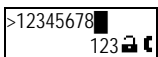
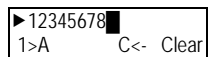
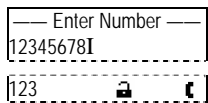
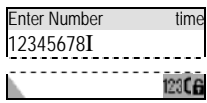
Action: Make a call using handset, handsfree, or headset mode (see page 9)

snom 300	snom 320	snom 360	snom 370
<p>Take the handset off the hook. Handset mode has been activated () and a dial tone is heard in the handset speaker. The display shows:</p>			
			
<p>or leave the handset on the hook and press  Speaker</p> <p>Handsfree mode will be activated () and a dial tone can be heard in the casing speaker. The display shows:</p>			
			
<p>or switch from handsfree to headset mode by pressing</p>			
			
<p>Headset mode will be activated ( / ) and a dial tone can be heard in the headset speaker. The display shows:</p>			
			
<p>↳ Make sure the phone is in numeric mode (see page 56), then enter the number using the alphanumeric keys (see page 55)</p>			
			
<p>Press  to confirm that number is complete.</p>			

Result: The phone number entered will be dialed.



You can also make a call using handset or handsfree mode without confirming the previously entered number:

snom 300	snom 320	snom 360	snom 370
Enter the number to be dialed. Lift the handset or press  .			

Result: The phone begins to dial.

Auto Completion (Number Guessing)

Note: The following setting must have been configured in advance:

-  Setup → Advanced → Behavior → *Number Guessing*: <ON>
-  Setup → Advanced → Behavior → *Number Guessing Minimum Length*: <2..4>



Action: Dial a supported format (see page 54) using auto completion (number guessing).

snom 300	snom 320	snom 360	snom 370
Enter a supported format (number or name → digits/letters) to be dialed.			

Result: After the minimum number (*Number Guessing Minimum Length*) has been entered, the phone will search the call lists (page 82) and the phone directory (page 81) for numbers/names containing those digits/letters and present the search results in a list on the display. The resulting list can be browsed using .

The **displayed** entry can be dialed by pressing  or continue entering numbers.

Action: Turn off auto completion (number guessing) temporarily

snom 300	snom 320	snom 360	snom 370
-	Press 	or press  S3	or press  S3

Result: The entered number will not be auto-completed by number guessing. Dial the number by pressing .

Call Completion

This call function allows you to establish calls successfully when the other party is busy or not answering.

Note: Your VoIP PBX must support this feature.

Enabling

Action: Enable call completion via the web or phone user interface:

snom 300	snom 320	snom 360	snom 370
<p>☞ Setup → Advanced → Behavior → <i>Call Completion</i>: <ON> ☞ Setup → Advanced → Behavior → <i>Peer to Peer Call Completion</i>: <ON></p>			
not supported		not supported	
or			
<p>☎ Enter the settings menu and navigate through the menu (see page 22): ☎ 6 Phone Behaviour → 6 Call Completion → On</p>			

When "Busy" (CCBS)

You can activate call completion when the called party *extB* is busy.

Activation

Action: Activate call completion when called party *extB* is busy

snom 300	snom 320	snom 360	snom 370
Activate Call Completion?	Activate Call Completion Cancel	----- Busy ----- Activate Call Completion?	Busy time Activate Call Completion? ..
Confirm with <input checked="" type="checkbox"/> or abort with <input type="checkbox"/>			

Result: Call completion has been activated and the display shows:

Waiting: extB	Waiting: extB Cancel Ok	— Call Completion — Waiting: extB	Call Completion time Waiting: extB
---------------	----------------------------	--------------------------------------	---------------------------------------

While Waiting

Action: Optionally: Continue using the phone while waiting for call completion

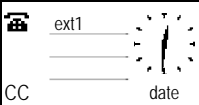
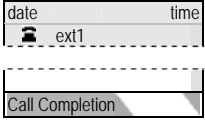

snom 300	snom 320	snom 360	snom 370
Press  to return to the idle screen			

Result: The idle screen is displayed and the message "CC" is shown on the display.

			
---	---	---	---

Call Completion

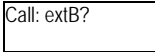
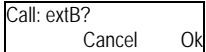
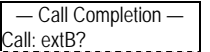
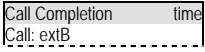
Action: Dial the number when called party *extB* becomes idle.

snom 300	snom 320	snom 360	snom 370
The following message will be displayed when the called party <i>extB</i> becomes idle:			
			
Press  to dial the number.			

Result: The call to the busy party *extB* could be completed.



On "No Responding" (CCNR)

You can activate call completion when the called party *extB* is not responding.

① **Note:** Be aware that activity detection only detects whether the phone you are calling is being used. It cannot detect whether the person you want to reach is in the room or not!

The following settings must have been configured in advance:

Snom 300 only:

-  Setup → Function Keys → Px → Context: <Active>
-  Setup → Function Keys → Px → Type: <Key Event>
-  Setup → Function Keys → Px → Number: F_CALL_COMPLETION

Activation

Action: Activate call completion when called party *extB* is not responding

snom 300	snom 320	snom 360	snom 370
<p>When the called party is not responding press:</p>			

Result: Call completion has been activated and the following message is displayed:

--	--	--	--

While Waiting

Action: Optionally: Continue using the phone while waiting for call completion

snom 300	snom 320	snom 360	snom 370
<p>Press to return to the idle screen</p>			

Result: The idle screen is displayed and the message “CC” is shown on the display.

--	--	--	--

Call Completion

Action: Dial the number when called party *extB* becomes available.

snom 300	snom 320	snom 360	snom 370
<p>Press to dial the number.</p>			

Result: The call to the non-responding party *extB* could be completed.

Call Termination

Action: Terminate a call





snom 300	snom 320	snom 360	snom 370
(1) Replace the handset, (2) press the handset hook (see page 9) or (3) press 			

Result: The call is terminated.

Redial

This function allows the redialing of previously dialed numbers (see page 82).

Action: Redial a previously dialed number

snom 300	snom 320	snom 360	snom 370
<p>Press</p> <p>LED3  P3</p> <p>Redial</p> <p>The previously dialed numbers are displayed, one at a time.</p> <p>Use  to navigate through the entries. Begin dialing the displayed or highlighted entry pick up the handset or by pressing .</p>	<p>Press </p> <p>Redial</p>	<p>Press </p> <p>Redial</p> <p>The list of previously dialed numbers is displayed.</p>	

Result: A previously dialed number is redialed.

Incoming Calls

Call Indication

An incoming call is indicated acoustically and visually:

Acoustic

- Ringtone (see page 34)

Visual







• Fast Blinking LEDs

- LED adjacent to  Free Function "Line" Key

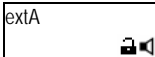
Note: Use the default settings (see page 41)
 Setup → Function Keys → Px:
 Context: <Active>, i.e. the extension for outgoing calls is used
 Type: <Line>
 Number: <empty>

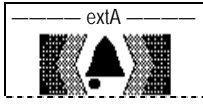
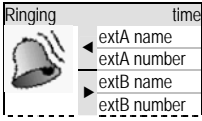

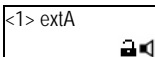
-  "Message" LED, see page 9
- Call Indication LED (snom 370 only), see page 9
- *Flashing backlight* (not available on snom 320), see page 32
- *Display*
 - Calling party's extension
 - Calling party's picture (snom 370 only)
 - Called party's extension/SIP Identity index

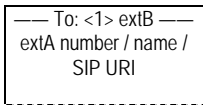
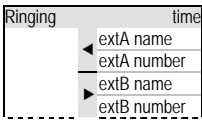
Example: Ringing Screen Appearance (calling party *extA*; called party *extB*)

snom 300	snom 320	snom 360	snom 370
			
When the following settings are made, the "ringing screen" will change appearance:			
<ul style="list-style-type: none">  Setup → Preferences → General Information → Show Identity Index: <ON>  Setup → Preferences → General Information → Ringer animation: <OFF> 			
			

Accepting Incoming Calls

Action: Accept an incoming call

snom 300	snom 320	snom 360	snom 370
Pick up the handset (→ enable <i>handset mode</i>) or press  (→ enable <i>handsfree mode</i>) or press  (→ enable <i>handsfree</i> or <i>headset mode</i> , if used)			

Result: The incoming call has been accepted.

Call Waiting

This call feature allows your phone to accept other incoming calls to an extension (SIP identity) *extB* already in an active call.

Note: The default setting has to be configured in advance:







Setup → Advanced → Audio → *Call Waiting Indication*:

<ON>: A recurring knocking sound will be heard in the background of the ongoing call to signal further incoming calls.

<VISUAL> Further incoming calls are indicated only on the display.

One free function “Line” key per call is required (see page 41).

Example: There is one active call from *extA* indicated by the permanently lit LED1.

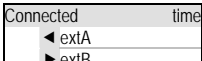
snom 300	snom 320	snom 360	snom 370
 LED1  P1 LED2  P2		 P1  LED1 P2  LED2	

Action: Receive another incoming call at *extC* while in an active call at *extA*.

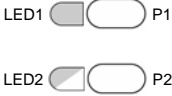
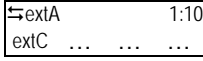
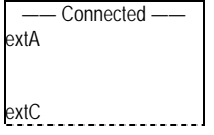
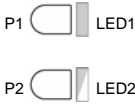
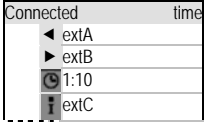



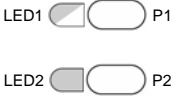
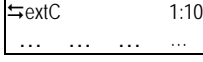
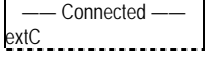
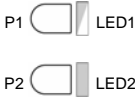
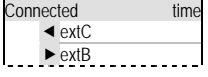





snom 300	snom 320	snom 360	snom 370
Another incoming call is signaled on the display and by the blinking LED2.			
 		 	
Answer the call by pressing the free function "Line" key next to the blinking LED2.			

Result: The first active call on the free function "Line" key P1 is placed on hold and the 2nd incoming call on the free function "Line" key P2 is accepted. This is indicated by a slowly blinking LED1 and a permanent lit LED2. Additionally a tone sequence can be played to remind you of the waiting call.

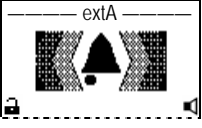
 		 	
--	---	--	--

Denying Incoming Calls

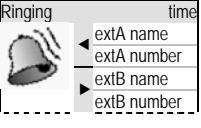
Action: Deny an incoming call to *extA*

snom 300	snom 320	snom 360	snom 370
 <p>Press </p>	 <p>Deny </p>	 <p>Press  or </p> <p></p>	 <p>Deny </p>

Result: The incoming call has been denied.

Denying Incoming Calls Automatically

Note: The following settings must have been configured in advance (via mass deployment or manually):

Setup → Advanced → Behavior → Deny All Feature: <ON>









Snom 300 only:

Setup → Function Keys → Px → Context: <Active>

Setup → Function Keys → Px → Type: <Key Event>

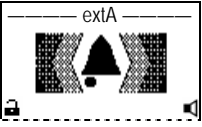
Setup → Function Keys → Px → Number: F_DENYALL

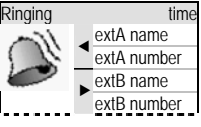
Action: Deny incoming calls to *extA* automatically

snom 300	snom 320	snom 360	snom 370
 <p>F_DENYALL </p>	 <p>DenyAll </p>	 <p>Press </p> <p></p>	 <p>Deny All </p>

Result: The incoming call is denied and the related caller information is added to a *deny list* in the phone's directory (see page 81). All calls from this number will be rejected automatically.

DND (Do Not Disturb) Mode

Note: The following settings must have been configured in advance:

☞ Operation → Directory / Address Book → Add or Edit Entry/Contact Type: <VIP>





The following configuration is mandatory on snom 300, but optional for snom 320/360/370 if additional feedback via LEDx is desired:

☞ Setup → Function Keys → Px → Context: <Active>



☞ Setup → Function Keys → Px → Type: <Key Event>

☞ Setup → Function Keys → Px → Number: F_DND



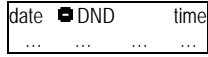
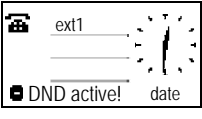
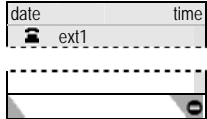

Action: Activate DND (Do Not Disturb) Mode

snom 300	snom 320	snom 360	snom 370
Press LEDx   Px	Press  DND	or press	LEDx   Px

Result: DND Mode has been activated. Further incoming calls will be rejected (except those from "VIP" numbers). The display shows:

			
or			
LEDx lights up LEDx   Px			

Action: Deactivate DND (Do Not Disturb) Mode

snom 300	snom 320	snom 360	snom 370
Press LEDx   Px	Press  DND	or press	LEDx   Px

Result: DND Mode has been deactivated. Further incoming calls will not be rejected anymore.

Call Forwarding

This feature allows you (*extB*) to forward an incoming call from *extA* to another phone number (*extC*), e.g. a cell phone or voice mailbox.

The following call forwarding events can be configured:

- **Off:** Call forwarding is *deactivated by default*.
- **Always:** Incoming calls are immediately forwarded.
- **Busy:** Incoming calls are immediately forwarded when the phone is busy.
- **Time:** Call forwarding is activated when the time (in seconds) entered has passed without the call having been answered.

Always

Action: Activate call forwarding event “Always” (to *extC*)

snom 300	snom 320	snom 360	snom 370
<p>☰ Setup → Preferences → Call Forwarding → Always → Target: <extC> ☰ Setup → Preferences → Call Forwarding → Event: <Always> Save by clicking on Save</p>			
or			
<p>☎ Call Forwarding → Always Press <input checked="" type="checkbox"/> Enter “Always target” <extC> Press <input checked="" type="checkbox"/></p>		<p>☎ 7 Call Forwarding → 3 Always Target Enter <extC> and press <input checked="" type="checkbox"/> → 1 Call Forwarding Event Choose “Always” and press <input checked="" type="checkbox"/></p>	
<p>ⓘ Note: To turn the call forwarding event “Always” on and off more quickly and conveniently, it can be programmed onto one of the free function keys.</p>			
<p>The following setting must have been configured in advance:</p> <p>☰ Setup → Function Keys → Px → <i>Context</i>: <Active> ☰ Setup → Function Keys → Px → <i>Type</i>: <Key Event> ☰ Setup → Function Keys → Px → <i>Number</i>: F_REDIRECT or F_REDIRECT:extC</p> <p style="text-align: center;">Press <input type="text"/> Px F_REDIRECT</p>			

Result: Call forwarding is activated. Incoming calls are immediately forwarded to *extC*.

<div style="border: 1px solid black; padding: 2px;"> ext1 time CFwd: <i>extC</i> </div>	<div style="border: 1px solid black; padding: 2px;"> date CFwd: <i>extC</i> time </div>	<div style="border: 1px solid black; padding: 2px;"> ☎ ext1 CFwd: <i>extC</i> date </div>	<div style="border: 1px solid black; padding: 2px;"> date time ☎ ext1 CFwd: <i>extC</i> </div>
---	---	---	---

Busy

Action: Activate call forwarding event “when busy” (to *extC*)

snom 300	snom 320	snom 360	snom 370
<p>☞ Setup → Preferences → Call Forwarding → Busy → Target: <extC> ☞ Setup → Preferences → Call Forwarding → Event: <When Busy> Save by clicking Save</p>		<p>or</p>	
<p>☎ Call Forwarding → Busy Press ✓ Enter “Busy target” <extC> Press ✓</p>		<p>☎ 7 Call Forwarding → 4 Busy Target Enter <extC> and press ✓ → 1 Call Forwarding Event Choose “When Busy” and press ✓</p>	

Result: Call forwarding is activated. Incoming calls are immediately forwarded to *extC* when one of the extensions is busy.

<p>ext1 time CFwd <i>extC</i> 🔊</p>	<p>date CFwd <i>extC</i> time </p>	<p>☎ ext1 _____ _____ CFwd: <i>extC</i> date</p>	<p>date time ☎ ext1 ----- ----- CFwd: <i>extC</i></p>
--	---	--	--

Timeout**Action:** Activate call forwarding event “on timeout” (to *extC*)

snom 300	snom 320	snom 360	snom 370
<p>☞ Setup → Preferences → Call Forwarding → Timeout → Target: <extC></p> <p>☞ Setup → Preferences → Call Forwarding → Timeout → Timeout (sec): <time in sec></p> <p>☞ Setup → Preferences → Call Forwarding → Event: <After Timeout></p> <p>Save by clicking on Save</p>	<p>☞ Call Forwarding → Time</p> <p>Press <input checked="" type="checkbox"/></p> <p>Enter “Timeout target” <extC></p> <p>Press <input checked="" type="checkbox"/></p> <p>Enter <time in sec></p> <p>Press <input checked="" type="checkbox"/></p>	<p>☞ 7 Call Forwarding → 5 Timeout Target</p> <p>Enter <extC> and press <input checked="" type="checkbox"/></p> <p>→ 2 Call Forwarding Time</p> <p>Enter <time in sec> and press <input checked="" type="checkbox"/></p> <p>→ 1 Call Forwarding Event</p> <p>Choose “On Timeout” and press <input checked="" type="checkbox"/></p>	

Result: Call forwarding is activated. Incoming calls are forwarded to *extC* when the time (in seconds) entered has passed without the call having been answered.







<div style="border: 1px solid black; padding: 5px;"> <div style="display: flex; justify-content: space-between;"> ext1 time </div> <div style="border: 1px solid black; padding: 2px;"> CFwd: <i>extC</i> </div> </div>	<div style="border: 1px solid black; padding: 5px;"> <div style="display: flex; justify-content: space-between;"> date CFwd: <i>extC</i> time </div> <div style="border: 1px solid black; padding: 2px;"> </div> </div>	<div style="border: 1px solid black; padding: 5px;"> <div style="display: flex; justify-content: space-between;"> ☞ ext1 date </div> <div style="border: 1px solid black; padding: 2px;"> CFwd: <i>extC</i> </div> </div>	<div style="border: 1px solid black; padding: 5px;"> <div style="display: flex; justify-content: space-between;"> date time </div> <div style="border: 1px solid black; padding: 2px;"> ☞ ext1 </div> <div style="border: 1px solid black; padding: 2px; margin-top: 5px;"> CFwd: <i>extC</i> </div> </div>
---	---	---	---

Active Calls

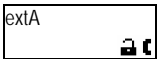
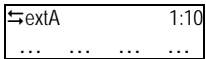
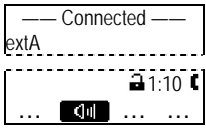
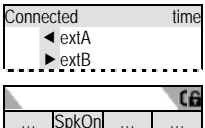

Audio Operation Modes

The audio operation modes *handset*, *handsfree*, and *headset* can be alternated during active calls.



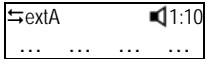
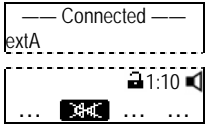

Action: Switch between *handset*, *handsfree*, and *headset* mode during an active call.

snom 300	snom 320	snom 360	snom 370
	 <p>(no symbol when in handset mode)</p>		
<p>Press</p>  <p>Speaker</p>	<p>Press</p>  <p>S2</p>	<p>Press</p>  <p>Speaker</p> <p>or</p>  <p>S2</p>	<p>Press</p>  <p>Speaker</p> <p>or</p>  <p>S2</p>

Result: Handsfree mode has been activated and the display shows:

			
---	---	---	---

You can either opt to stay in *handsfree mode* by replacing the handset or return to *handset mode* by pressing Speaker  or switch to *headset mode*:

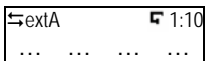
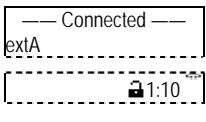
<p>Press </p>	<p>Press </p>	<p>Press </p>
		







Result: Headset Mode has been activated. The display shows:

Mute / Unmute







This function allows you to mute the microphone of the active audio device during a call, i.e. the other party cannot hear you. Unmute the microphone to return to normal conversation.

Mute

Action: Mute the microphone of the active audio device during a call.







snom 300	snom 320	snom 360	snom 370
Press LED6   P6 Mute	Press Mute  S2	 Mute  S1	or press  Mute  S1

Result: The microphone of the active audio device has been muted and the other party cannot hear you. This is indicated as follows:





extA 1:10 Mute  LED 6 lights up LED6   P6 Mute	extA 1:10 ... Unmute ... 	Connected extA Unmute 1:10 	Connected time extA extB Unmute ... 
---	--	---	---

Unmute

Action: Unmute the microphone of the active audio device during a call.

snom 300	snom 320	snom 360	snom 370
Press LED6   P6 Mute	Press Unmute  S2	 Unmute  S1	or press  Unmute  S1

Result: The microphone of the active audio device has been activated again. This is indicated as follows:







LED6   P6 Mute	extA 1:10 ... Mute ... 	Connected extA Mute 1:10 	Connected time extA extB Mute ... 
---	--	---	---

Multiple Speaker Mode

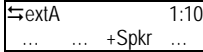

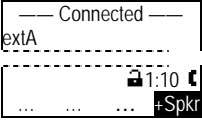
This option is only available during an active call and allows you to use two speakers simultaneously for listening (handset/casing speaker or headset/casing speaker).

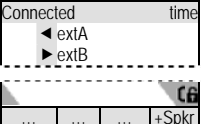
Enable Casing Speaker

Action: Turn on the casing speaker during an active call when in handset mode.

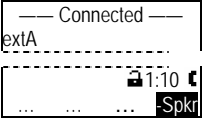

snom 300	snom 320	snom 360	snom 370
Not applicable	 Press  S3	 Press  S4	 Press  S4

Result: The casing speaker has been activated as indicated by the changing text/icon above the corresponding context-sensitive key

		
---	---	---

Disable Casing Speaker

Action: Turn on the casing speaker during an active call in handset mode.

snom 300	snom 320	snom 360	snom 370
	Press  S3	Press  S4	Press  S4

Result: The casing speaker has been deactivated as indicated by the changing text/icon above the corresponding context-sensitive key

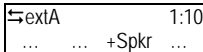
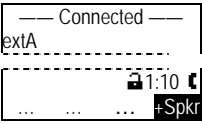
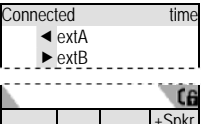

		
---	---	---

Hold and Resume



This call function allows you (*extB*) to place an active call from *extA* on hold. When placing a call on hold, your IP PBX might play a melody or message to the other party while waiting. Other calls can be received and made while having a call on hold.

Hold

Action: Place an active call on hold

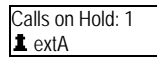
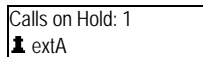
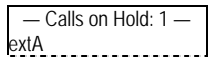

snom 300	snom 320	snom 360	snom 370
Not applicable	Press the free function “Line” key whose adjacent LED is <i>lit up</i> 		
	or press  Hold		

Result: The current call is placed on hold. This is indicated by the slowly blinking LED of the free function “Line” key. The following message is displayed:



			
---	---	---	---



Resume

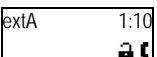
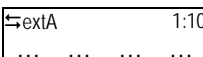

Action: Resume a held call

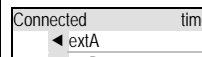
snom 300	snom 320	snom 360	snom 370
Not applicable	Press the free function “Line” key whose adjacent LED is <i>blinking slowly</i> 		
	or press  Hold		

Result: The held call is resumed. The number of the calling party is displayed.

			
---	---	---	---

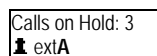
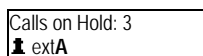
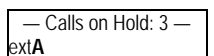
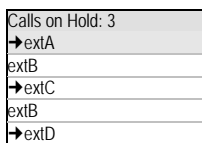
Several calls, e.g. to *extA*, *extC*, and *extD*, can be placed on hold simultaneously. Navigate through the calls on hold with  and resume the highlighted one with .

			
Press  or 			

Calls on Hold: 3 ☎ extC	Calls on Hold: 3 ☎ extC	— Calls on Hold: 3 — ☎ extC	extB
----------------------------	----------------------------	--------------------------------	------









Call Transfer

This call function allows your phone (*extB*) to transfer an active call from *extA* to a third phone (*extC*) without announcing the call to *extC* (“Blind Transfer”) or with prior announcement (“Attended Transfer”).

Note: Your VoIP PBX must support this functionality.

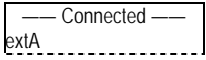
Blind Transfer

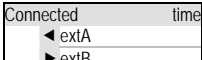





Action: Perform a “Blind Transfer”

snom 300	snom 320	snom 360	snom 370
 <p>Press</p> <p>LED5   P5</p> <p>Transfer</p>		 <p>Press</p> <p></p> <p>Transfer</p>	
<p><i>extA</i> will be placed on hold automatically.</p> <p>Enter <i>extC</i> and press  or hang up to confirm.</p>			

Result: The call from *extA* is blindly transferred to *extC*. If *extC* is busy or not responding there will be no feedback to *extB* and the call would be forwarded to *extC*'s voicemail if so configured.

Attended Transfer

Action: Perform an “Attended Transfer”

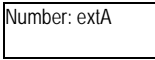
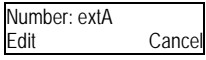
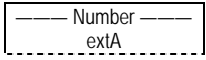
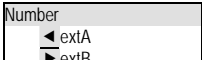
snom 300	snom 320	snom 360	snom 370
<p>Place the caller on hold (see page 71), and then dial <i>extC</i>'s number. When <i>extC</i> answers, announce the call. If <i>extC</i> wishes to accept the call, press:</p>			
<p>LED5   P5</p> <p>Transfer</p>		<p></p> <p>Transfer</p>	
<p>The list of held calls is displayed. If there is more than one held call, choose the party you want to transfer by using  and press  or  to confirm.</p>			
			

Result: The call from *extA* is transferred to *extC*.

Conference

This call function allows your phone (**extA**) to establish a three-party conference, i.e. three phone parties can communicate with each other.

Establishing

Action: Establish three-party conference on your phone (**extA**)

snom 300	snom 320	snom 360	snom 370
Call extB and place the call on hold (see page 71) Call extC and initiate the conference as follows:			
<div style="border: 1px solid black; padding: 2px; width: fit-content;"> extC 0:10 Cnf.On </div> Press <input checked="" type="checkbox"/>	Press Cnf.On S4	 Conference S4	or press Cnf.On S4

Result: The three-party conference has been established. The participants **extA**, **extB**, and **extC** can hear each other. This is indicated as shown:

<div style="border: 1px solid black; padding: 2px; width: fit-content;"> extC 0:10 Cnf.Off </div>	Cnf.Off S4	 S4	Cnf.Off S4
---	-------------------	--------	-------------------

Disconnecting

Action: Disconnecting a Conference

snom 300	snom 320	snom 360	snom 370
Press <input checked="" type="checkbox"/>	Press Cnf.Off S4	 Conference S4	or press Cnf.Off S4

Result: The conference has been disconnected; **extB** and **extC** are placed on hold:

<div style="border: 1px solid black; padding: 2px;"> Calls on Hold: 2 extC </div>	<div style="border: 1px solid black; padding: 2px;"> Calls on Hold: 2 extC </div>	<div style="border: 1px solid black; padding: 2px;"> — Calls on Hold: 2 — extC </div>	<div style="border: 1px solid black; padding: 2px;"> Calls on Hold: 2 → extC → extA → extB → extA </div>
---	---	--	--

Call Recording

You can record active calls. The recordings are available through your voice mailbox (see page 87)

① **Note:** Your VoIP PBX must support this functionality.

Turn On

Action: Turn On Call Recording

snom 300	snom 320	snom 360	snom 370
Not supported	Press  Record		

Result: Recording starts. A blinking symbol ● is shown in the display while recording.

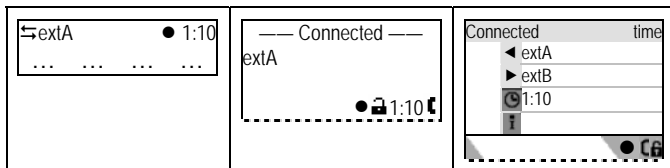

Turn Off

Action: Turn Off Call Recording

snom 300	snom 320	snom 360	snom 370
Not supported	Press  Record		

Result: Recording stops. The recording is now available in your voice mailbox and a message waiting indication is sent to your phone.

Advanced Phone Functions

Hot Desking

The basic functionality allows logging off existing user accounts (extensions/SIP identities) and logging on new user accounts (extensions/SIP identities).

Note: This feature can be enhanced to allow automatic provisioning of customized phone configuration when different users logon to your phone; the enhanced functionality must be supported by your VoIP PBX.



Logoff All Users (Extensions/SIP Identities)

Action: Logoff all users (extensions/SIP identities)

snom 300	snom 320	snom 360	snom 370
<p>☞ See page 39 "Removing All Extensions (SIP Identities)"</p> <p>or</p> <p>☎ To logoff off all extensions (SIP identities) more quickly and conveniently, it can be programmed onto one of the free function keys.</p>			
<p>Note: The following setting must have been configured in advance:</p> <ul style="list-style-type: none"> ☞ Setup → Function Keys → Px → <i>Context</i>: <Active> ☞ Setup → Function Keys → Px → <i>Type</i>: <Key Event> ☞ Setup → Function Keys → Px → <i>Number</i>: F_LOGON_USER 			
<p>☎ Press <input type="text" value="Px"/> F_LOGON_USER</p> <p>or</p> <p>☎ 5 Identity → 5 Logoff All</p> <p>Press <input checked="" type="checkbox"/></p>			
Not supported	<p>Log off all user</p> <p>Log off all users?</p> <p>Cancel</p>	<p>Logoff All</p> <p>Log off all users?</p>	<p>Logoff All</p> <p>Log off all users?</p> <p>time</p>
<p>Confirm with <input checked="" type="checkbox"/> (or abort with <input type="checkbox"/>)</p>			
<p>Warning: If you confirm, all currently configured extensions (SIP identities) will be unregistered immediately and their configuration data deleted from the phone.</p>			
<p>Result: All extensions are unregistered and removed from your phone configuration. The phone is placed out of operation and the logon wizard will be shown on the display.</p>			

Logon New User (Extension/SIP Identity)

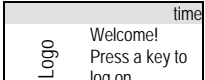
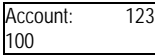
Action: After logging off all users (see page 79) you can logon a new user

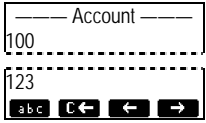
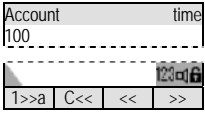
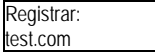
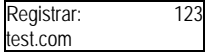
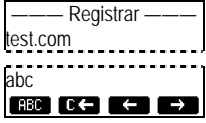
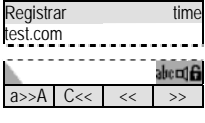
No Logon Wizard screen	No Logon Wizard screen	The Logon Wizard screen is displayed:	
			
Press a key.			
Change the input mode as needed and enter the new extension to log on, e.g. 100			
			
Confirm with <input checked="" type="checkbox"/> . Change the input mode as needed and enter the registrar of the new extension to log on, e.g. test.com			
			
Confirm with <input checked="" type="checkbox"/> (or abort with <input type="checkbox"/>)			

Result: The phone attempts to register the new user (see page 19).

① Note: The enhanced functionality requires the following steps:

1. The log off information is sent to the VoIP PBX via "Action URL" <Log off>
2. The new user information is sent to the VoIP PBX via "Action URL" <Log on>
3. The VoIP PBX sends a reboot request to the phone
4. The phone restarts and will be provisioned with customized configuration settings

Directory

The built-in phone directory stores the names and phone numbers of your contacts and allows you to group them into “friends”, “family members”, “colleagues”, and “VIPs”, which groups can be assigned distinct ringtones (see page 35).

snom 300	snom 320	snom 360	snom 370
100 entries max.		250 entries max.	
Contact Types: Friends, Family, Colleagues, VIP, Deny List			
<p>Note: We recommend using the web user interface to add or edit entries, import or delete directory more conveniently:</p> <ul style="list-style-type: none"> Releases < 7: Operation → Address Book Release 7: Operation → Directory <p> For further information read the instructions for release 6²⁵ and release 7²⁶ in our online knowledge database.</p>			

Action: Access the phone directory

snom 300	snom 320	snom 360	snom 370
Press LED4 P4 Directory	Press Dir S3	Directory S3	or press Directory S3

Result: The phone directory entries will be displayed. Use for navigation through the list. Dial the highlighted entry by pressing .

Call Lists

Your phone maintains locally stored lists of missed, received, and dialed calls. Each list entry has a timestamp and shows the called or calling party number respectively.















A maximum of 100 entries per list is supported.

Note: When the phone is rebooted, the entries on all lists are cleared. Save them to another file if you need to keep the information.

Repeated calls from or to the same number will show the time of the last call and the total number of calls dialed/missed/received.

We recommend using the web user interface to import or delete call list entries:  Operation → Home

Action: Access call lists on the web or phone user interface.

snom 300	snom 320	snom 360	snom 370
 Operation → Home → Dialed Numbers / Missed Calls / Received Calls or  Press			
 Call History: Missed Select a list by pressing	CHist  S2 Call History: Missed Received Dialed Select a list by pressing	  S2 Received Dialed	CHist  S2 Call History Missed Received Dialed
 Press 	Missed  Received  Dialed  S1 S2 S4	Select a list by pressing  or  Press 	

Result: The **Call History Lists** are displayed. Dial the highlighted entry by pressing . (see also page 62)

Minibrowser

This function enables your phone to use services provided by standard web servers using the HTTP/HTTPS protocol. Typical services are:

- To-do lists
- Stock information
- Weather information
- Provisioning
- Scheduler
- Phone directory

Availability

snom 300	snom 320	snom 360	snom 370
-	-	Release 6	-
Release 7	Release 7	Release 7	Release 7

Access

You can configure access to the Minibrowser via web user interface using “Action URLs” pointing to XML files.

Action: Access the Minibrowser via phone user interface.

snom 300	snom 320	snom 360	snom 370
<p>The following settings must have been configured in advance in order to access the Minibrowser from the phone user interface.</p> <ul style="list-style-type: none"> ☞ Setup → Function Keys → Px → <i>Context</i>: <Active> ☞ Setup → Function Keys → Px → <i>Type</i>: <Action URL> ☞ Setup → Function Keys → Px → <i>Number</i>: <URL to XML Minibrowser Application> <p style="text-align: center;">☎ Press</p> <p style="text-align: center;">LEDx <input type="checkbox"/> <input type="checkbox"/> Px</p> <p style="text-align: center;">Action URL</p>			

Result: The XML file will be loaded and the Minibrowser displays the application on the screen.

Presence

This feature allows you to publish a presence state to indicate your current communication status in order to inform your contacts of your availability and willingness to communicate.

ⓘ Note: Your VoIP PBX must support this functionality. This feature is only available from firmware release 7 onwards.

The following settings must have been configured in advance:

☞ Setup → Advanced → SIP/RTP → Publish Presence: <ON>

☞ Setup → Identity X → SIP → Contact List: <ON>

☞ Setup → Identity X → SIP → Contact List URI: <SIP URI>

For snom 320 / 360 / 370 only:







Configure one context-sensitive key S1...S4 to call up the "Presence State" list and another one to call up the "Contacts" list:

☞ Setup → Function Keys: Sx <Presence> / <Contacts>

Changing the Presence State

The default presence state is **Offline**, i.e. your contacts are informed of your availability. You can change your presence state to one of the following options: Online, Offline, Invisible, Busy.

Action: Change your presence state









snom 300	snom 320	snom 360	snom 370
<p>Press </p> <p>Configuration <input type="text" value="Reg"/></p> <p>Press <input checked="" type="checkbox"/></p> <p>Choose the currently active extension (*) by pressing</p> <p> or </p> <p><input type="text" value="1* ext1"/></p> <p>Press 3x </p> <p><input type="text" value="1* Presence"/> Edit</p> <p>Press <input checked="" type="checkbox"/></p> <p>Presence State Offline</p>	<p>Presence</p> <p><input type="text" value="Sx"/></p>	<p>Presence</p> <p></p> <p><input type="text" value="Sx"/></p>	<p>Presence</p> <p><input type="text" value="Sx"/></p>
<p><input type="text" value="Presence State Offline"/></p>	<p><input type="text" value="Presence State Offline"/></p>	<p><input type="text" value="Presence State Offline"/></p> <p>Online</p> <p>Busy</p> <p>Invisible</p>	<p><input type="text" value="Presence State Offline"/></p> <p>Offline</p> <p>Online</p> <p>Busy</p> <p>Invisible</p>
<p>Select your presence state by pressing  or </p> <p>Confirm with <input checked="" type="checkbox"/> or abort with <input type="checkbox"/></p>			

Result: Your presence state has been changed and will be published to your contacts.







Contact Presence

The **Contacts** list shows the presence state of your contacts without you having to call them.

Action: Check the presence state of your contacts

snom 300	snom 320	snom 360	snom 370
not supported	not supported	Press	
		  Sx	Contacts  Sx
		 Contacts  Contact 2  Contact 3	Contacts  Contact 1  Contact 2  Contact 3

Result: The **Contacts** list is displayed and you can check the presence state of your contacts, as indicated by the following symbols, by using  :

 Online	 Online
 Offline	 Offline
 Busy	 Busy

Voice Mailbox

Your voice mailbox messages, which are usually stored on a media server of your local or hosted VoIP telephony system, can be accessed from your phone.

Note: Your VoIP telephony system must support this functionality.

New voice messages can be indicated both acoustically and visually as described below.

Acoustical Indication

A “Message Waiting Indication (MWI)” notification (tone sequence) can be played when a new message arrives. The “MWI Dial Tone” is a stuttering tone which can be played when a new call is started.

Action: Activate acoustical indication when a MWI arrives

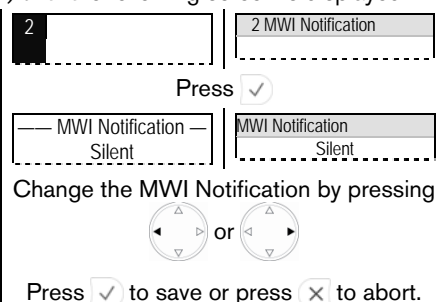

snom 300	snom 320	snom 360	snom 370
☰ Setup → Preferences → General Information → MWI Notification:			
<Silent>	MWI Notification is turned off		
<Beep>	Beep tone is played once		
<Reminder>	Beep tone is played repeatedly		
☰ Setup → Preferences → General Information → MWI Dial Tone:			
<Normal>	MWI Dial Tone is turned off		
<Stutter>	Stuttering Dial Tone is played		
or			
☎ Enter the settings menu (see page 25) and navigate through the menu (see page 22) until the following screen is displayed:			
Not supported			

Result: The MWI configuration has been changed.





Visual Indication

Message LED

The “Message LED” starts blinking when new MWIs arrive and stops when all messages have been retrieved.









snom 300	snom 320	snom 360	snom 370
	Message  yellow		Message  red

Idle Screen Symbols/Messages

snom 300	snom 320	snom 360	snom 370
Not supported	<div style="border: 1px solid black; padding: 5px;"> date ext1 time ... VMail ... VMail  S2 </div>	<div style="border: 1px solid black; padding: 5px;">  ext1 -----  1 new 0 old messages  </div>	<div style="border: 1px solid black; padding: 5px;"> date ext1 time ----- ----- 1 new 0 old messages  VMail </div>

Retrieve New Messages

Action: Listen to your new messages

snom 300	snom 320	snom 360	snom 370										
Press 	Press VMail  S2	 Retrieve   S4 <div style="border: 1px solid black; padding: 5px;"> Mailbox of: ext1@... You have 1 new 0 old messages ----- Confirm with  or abort with  </div>	or press VMail  S4 <div style="border: 1px solid black; padding: 5px;"> <table style="width: 100%; border-collapse: collapse;"> <tr> <td style="width: 80%;">Mailbox of:</td> <td style="width: 20%; text-align: right;">time</td> </tr> <tr> <td>ext1@...</td> <td></td> </tr> <tr> <td>You have 1 new</td> <td></td> </tr> <tr> <td>0 old messages</td> <td></td> </tr> <tr> <td>Go to Mailbox?</td> <td></td> </tr> </table> </div>	Mailbox of:	time	ext1@...		You have 1 new		0 old messages		Go to Mailbox?	
Mailbox of:	time												
ext1@...													
You have 1 new													
0 old messages													
Go to Mailbox?													

Result: Your voice mailbox is called and you are able to listen to your new and old messages.

Extension Monitoring and Call Pickup

This feature allows you to monitor the call state of other extensions and to answer calls to these extensions. It is very useful for a user, especially a phone receptionist, to know the call state of other phones so that he or she knows if a call can be successfully made to a phone.

① **Note:** Your VoIP PBX must support this functionality.

- Single subscriptions (RFC 4235 compliant)
- Event-list subscriptions (RFC4662 compliant); this feature is only available from firmware release 7 onwards.

Busy Lamp Field (BLF) feature

The following settings must have been configured in advance (see page 42)

☰ Setup → Function Keys → Px:



Context: <SIP Identity>

Type: <Extension>

Number: <Extension (SIP identity) of monitored phone>

The status of monitored extensions will be indicated by the LEDs adjacent to the previously configured free function “Extension” Keys.

Action: Monitor the call state of other phones.

snom 300	snom 320	snom 360	snom 370
	<i>Idle</i> state →	 LED off	
	<i>Ringing</i> state →	 LED blinking rapidly	
	<i>Busy or Connected</i> State →	 LED on	



“Calls” List

The “Calls” List represents a visual and functional extension of the BLF feature:

- The call state of monitored phones is displayed (snom 360/snom 370 only)
- The “Calls” list can be updated via an “Extension Monitoring & Call Pick Up List”, i.e. instead of handling each monitored resource individually, the monitoring phone can subscribe to an entire list and then receive notifications when the state of any of the monitored resources in the list changes.
- The “Calls” list may be offered automatically when a monitored extension gets a call and is in the *ringing state*. This behavior is turned off by default.

☞ Setup → Advanced → Behavior → Phone Behavior → Dialog-Info Call Pickup: <ON>
 ☞ Setup → Identity X → SIP → Extension Monitoring & Call Pick Up List: <ON>
 ☞ Setup → Identity X → SIP → Extension Monitoring & Call Pick Up URI: <SIP URI>
 ☞ Setup → Function Keys: S1 / S2 / S3 / S4 <Calls>

Action: Check the call status of other phones assigned to your call group.

snom 300	snom 320	snom 360	snom 370
Not supported	Not supported	Press  S4 ----- Calls ----- extC ♦ extD	 S4 Calls Calls time extA ➔ extB extC ♦ extD

Result: The *Calls* list is displayed and the call statuses *ringing* (➔) and *connected* (♦) of other phones assigned to your call group can be monitored. Use  to navigate when there are several simultaneous calls.

Call Pickup

Action: Pick up an incoming call to one of the monitored extensions

snom 300	snom 320	snom 360	snom 370
If the status of any of your monitored extensions is <i>ringing</i> you can select that call and press 			









Result: The selected call is picked up.

Appendix







Mapping of Context-Sensitive Function Keys

The following table gives an overview of the individual functions and its relation to the text or symbol displayed above each key as mentioned on page 8.

Idle screen

Functionality	snom 320 Text	snom 360 Icon	snom 370 Text
Calls up Registration List (default S1)	Reg		Reg
Calls up Call History Lists (default S2)	CHist		CHist
Calls up Phone Directory (default S3)	Dir		Dir
Speed Dial Prompt (default S4)	Speed		Speed
Calls up Presence State List	Presence		Presence
Calls up Contact List	-		Contacts
Calls up Extension Monitoring List	-		Calls
Retrieves new voice mail messages	VMail		VMail

Basic navigation

Functionality	snom 320 Text	snom 360 Icon	snom 370 Text
Cancels or aborts actions	Cancel		Cancel
Confirms actions	Ok		Ok
Scrolls down in a list	-		Down
Scroll up in a list	-		Up
Moves the Cursor to the right	-		<<
Moves the Cursor to the left	Next		>>
Moves to Next Item	Next		>>

“Edit” / “Enter number” screen

Functionality	snom 320 Text	snom 360 Icon	snom 370 Text
Deletes the last character	Clear		Clear
Deletes left character	C ←		C <<
Input Mode numeric → lower case	1→a		1>>a
Input Mode lower case → upper case	a→A		a>>A
Input Mode upper case → numeric	A→1		A>>1











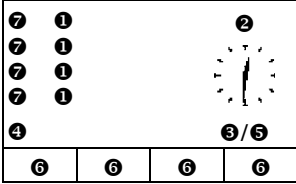

“Ringing”, “Calling”, “Connected”, “Holding”, “Transfer”, “Conference” screens

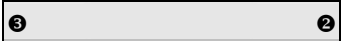
Functionality	snom 320 Text	snom 360 Icon	snom 370 Text
Denies an incoming call	Deny		Deny
Denies incoming calls automatically	DenyAll		DenyAll
Places a call on hold / Resumes a call	R		R
Establishes a three-party conference	Cnf.On		Cnf.On
Disconnects a three-party conference	Cnf.Off		Cnf.Off
Mutes the active microphone	Mute		Mute
Unmutes the microphone	Unmute		Unmute
Turns on hands free mode	-		SpOn
Turns off hands free mode	-		SpOff
Turns on casing speaker simultaneously	+Spkr		+Spkr
Turns off casing speaker	-Spkr		-Spkr

Mapping of Key Events

Key Event	Description	Page
F_REC	Toggles recording on/off during an active call.	8 / 78
F_RETRIEVE	Retrieves the mailbox messages.	87
F_REDIAL	Shows the list of dialed records. Pressing it twice dials the last dialed record.	62
F_REDIRECT	Toggles unconditional redirection on/off. Can be followed by redirection target.	68
F_HELP	Shows helpful information about the phone.	26 / 48
F_CALL_LIST	Shows the local call lists.	82
F_DENY	Denies an incoming call.	66
F_DENYALL	Denies an incoming call and put the caller in the deny list.	66
F_SPEED_DIAL	Offers the speed dial prompt.	45
F_REGS	Shows the SIP registrations menu.	
F_MUTE	Puts the current call on mute i.e. disabling microphone.	72
F_ADR_BOOK / F_DIRECTORY	Shows phonebook/directory.	81
F_CONFERENCE	Toggle control for 3-way conference.	77
F_TRANSFER	Used to transfer a call. Can be followed by the transfer target.	76
F_R	Holds / unholds current call.	74
F_DND	Toggles Do Not Disturb (DND) feature.	67
F_CC / F_CALL_COMPLETION	Enables Call Completion feature while making a call. (CCNR/CCSB)	59
F_LOGOFF_ALL	Logs off all SIP lines on the phone. (Needs confirmation)	39
F_LOGON_USER	Launches the logon wizard to setup a SIP line on the phone.	79
F_PRESENCE	Shows presence state for the current SIP line to be altered.	84
F_BUDDIES	Shows the contact list for the current SIP line.	86
F_DIALOG	Shows current calls being monitored.	90

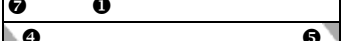
Idle Screen

Phone Type	Idle Screen on Display	Pos	Element
snom 300		1	Extension (SIP Identity)
snom 320		2	Time
snom 360		3	Date
		4	Status Line for Messages
snom 370		5	Status Indicators (Audio etc.)
		6	Text or Symbols for Context-sensitive Keys (see page 8 and 91)
		7	Extension Status Indicators
			
			
			
			
			

Accessories

The following accessories can be used together with your snom phone:

Expansion Module



The expansion module will extend the number of free function keys and LEDs (see page 7 and 40) by 42.

 For further [technical information](#)²⁷ consult our online knowledge database.

For questions regarding the product, please contact your snom Certified Sales Partner.

Version	snom 300	snom 320	snom 360	snom 370
Hardware Revision V1 (not cascable → only 1 module can be connected)	x	✓ FW V6 is required	✓	✓
Hardware Revision V2 (cascable → up to 3 modules can be connected)	x	✓	✓	✓
		FW Version 7 is required		

Headsets



The snom HS-MM2/HS-MM3 wired headsets are available in monaural style (one loudspeaker). They must be connected to the phone's **RJ 4P4C** jack via the adapter cable included in delivery.

 For further [technical information](#)²⁸ consult our online knowledge database.

For questions regarding the product, please contact your snom Certified Sales Partner.

Version	snom 300	snom 320	snom 360	snom 370
HS-MM2	x	✓	✓	✓
HS-MM3	✓	x	x	x

Wireless Headset Adapter



The snom *Wireless Headset Adapter* connects any [supported wireless headset](#) to your snom phone (see restrictions and firmware requirements below). That allows you to answer and terminate calls directly from your headset device (Electronic Hook Switch feature)

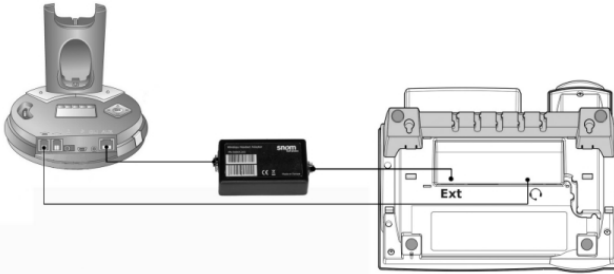

For further [technical information](#)²⁹ consult our online knowledge database or download the [user manual](#)³⁰.

For questions regarding the product, please contact your snom Certified Sales Partner.

Version	snom 300	snom 320	snom 360	snom 370
Wireless Headset Adapter	x	✓	✓	✓
		FW Version > 6.5.5 is required		

Power Consumption

Power Consumption	snom 300	snom 320	snom 360	snom 370
Power adapter				
• Typical (watts)	approx. 1.7 – 2.1	approx. 1.7 – 2.2	approx. 1.8 – 2.3	approx. 1.9 – 2.4
PoE				
• Typical (watts)	N/A	approx. 2.0 – 2.3	approx. 2.2 – 2.5	approx. 2.3 – 2.6

FCC Statement

For snom snom3x0 VoIP phones

This equipment has been tested and found to comply with the limits for a class B digital device, pursuant to Part 15 of the FCC rules.

These limits are designed to provide reasonable protection against harmful interference in a residential installation. This equipment generates, uses and can radiate radio frequency energy and, if not installed and used in accordance with the instructions, may cause harmful interference to radio communications. However, there is no guarantee that interference will not occur in a particular installation.

If this equipment does not cause harmful interference to radio or television reception, which can be determined by turning the equipment off and on, the user is encouraged to try to correct the interference by one or more of the following measures:

- Reorient or relocate the receiving antenna.
- Increase the separation between the equipment and receiver.
- Connect the equipment into an outlet on a circuit different from that to which the receiver is connected.
- Consult the dealer or an experienced radio/TV technician for help.

HAC (Hearing Aid Compatible): The measurements are conducted according to FCC 47 CFR 68.316 and 68.317 (edition 2005).

Do not make any changes or modifications to equipment without seeking approval from the party responsible for compliance. Unauthorized changes or modifications could void the user's authority to operate the equipment.

